



### Features

- SOP package 8 Pin type in miniature design (9.4×4.4×2.1mm / .370×.173×.079inch)
- Low driver power requirements (TTL/CMOS Compatible)
- Contact form: Normally-On (2b)
- Load voltage: 60V max.
- On-Resistance: 1.5Ω max.
- 1500 Vrms Input/Output isolation
- Tape & Reel version available

### Applications

- Telecommunications (PC, Electronic notepad)
- Measuring and Testing equipment
- Industrial control
- Security equipments
- High speed inspection machine

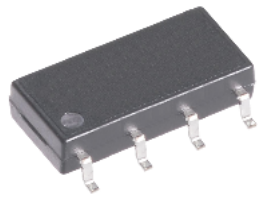

SOP-8

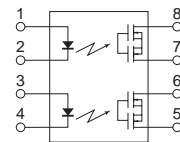

1,3. LED Anode  
 2,4. LED Cathode  
 5,6. Drain (MOSFET)  
 7,8. Drain (MOSFET)

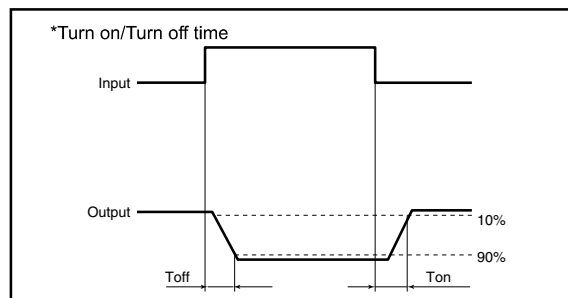

### TYPES

Category	Output rating <sup>**1</sup>		Part No.	Packing quantity
	Load voltage	Load current		
AC/DC	60V	400mA	GAQW412S	1-reel: 1,000 pcs.

### Absolute Maximum Ratings (Ambient Temperature: 25°C)

Item		Symbol	Value	Units	Note
Input	Continuous LED Current	IF	50	mA	
	Peak LED Current	IFP	500	mA	f=100Hz, duty=1%
	LED Reverse Voltage	VR	5	V	
	Input Power Dissipation	PIn	75	mW	
Output	Load Voltage	VL	60	V(AC peak or DC)	
	Load Current	IL	400	mA	
	Peak Load Current	IPeak	0.6	A	1ms(1 pulse)
	Output Power Dissipation	Pout	300	mW	
Total Power Dissipation		PT	350	mW	
I/O Breakdown Voltage		VI/O	1500	Vrms	RH=60%, 1min
Operating Temperature		Topr	-40 to +85	°C	
Storage Temperature		Tstg	-40 to +100	°C	
Pin Soldering Temperature		Tsol	260	°C	10 sec max.

### Electrical Specifications (Ambient Temperature: 25°C)

Item		Symbol	MIN.	TYP.	MAX.	Units	Conditions
Input	LED Forward Voltage	VF		1.2	1.4	V	IF=10mA
	Operation LED Current	IFon		0.5	3.0	mA	
	Recovery LED Current	IFoff	0.1	0.4		mA	
	Recovery LED Voltage	VFoff	0.5			V	
Output	On-Resistance	Ron		0.8	1.5	Ω	IF=0mA,IL=100mA, Time to flow is within 1 sec.
	Off-State Leakage Current	ILeak			1	uA	IF=5mA,VL=60V
	Output Capacitance	Cout		165		pF	IF=5mA,VL=0V, f=1MHz
Transmission	Turn-Off Time	Toff		0.5	2.0	ms	IF=5mA, IL=100mA
	Turn-On Time	Ton		0.25	1.0	ms	
Coupled	I/O Isolation Resistance	RI/O	10 <sup>10</sup>			Ω	DC500V
	I/O Capacitance	CI/O		0.8		pF	f=1MHz

### Reference Data

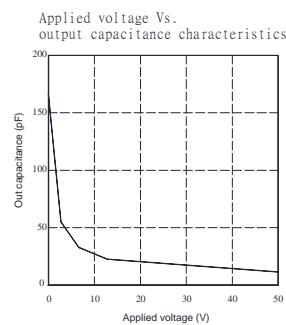
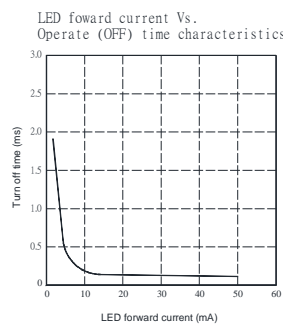
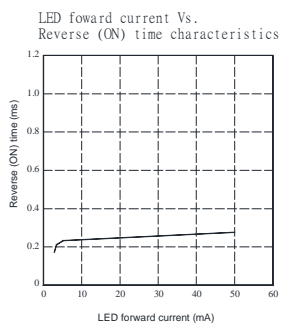
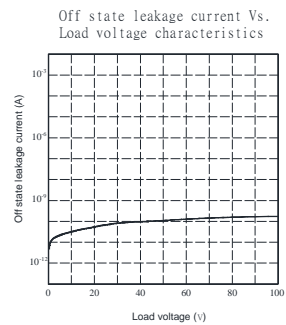
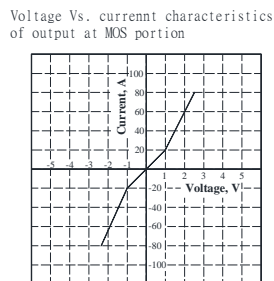
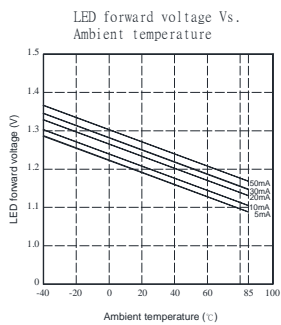
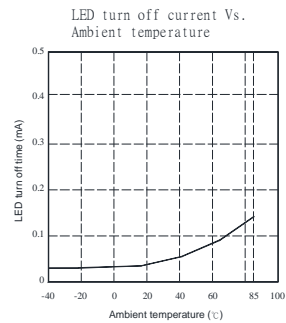
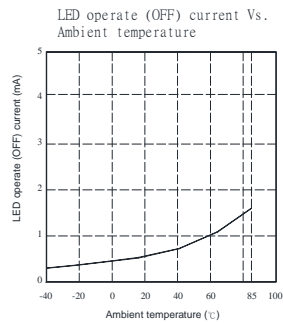
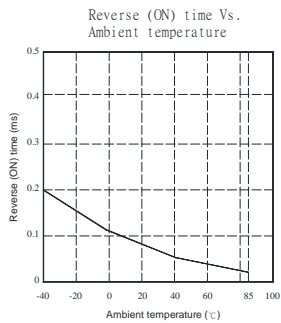
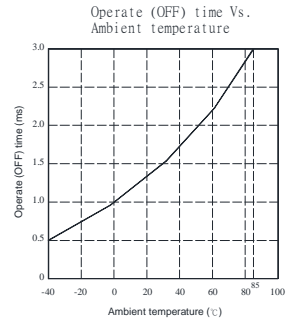
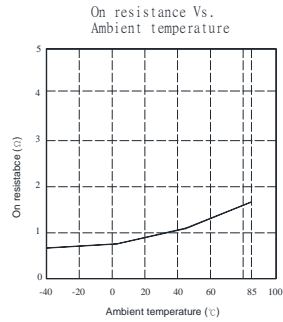
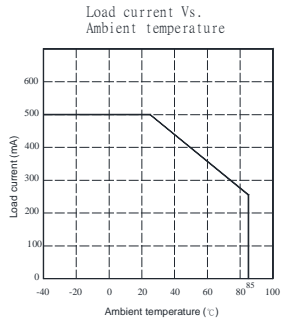

### Dimensions

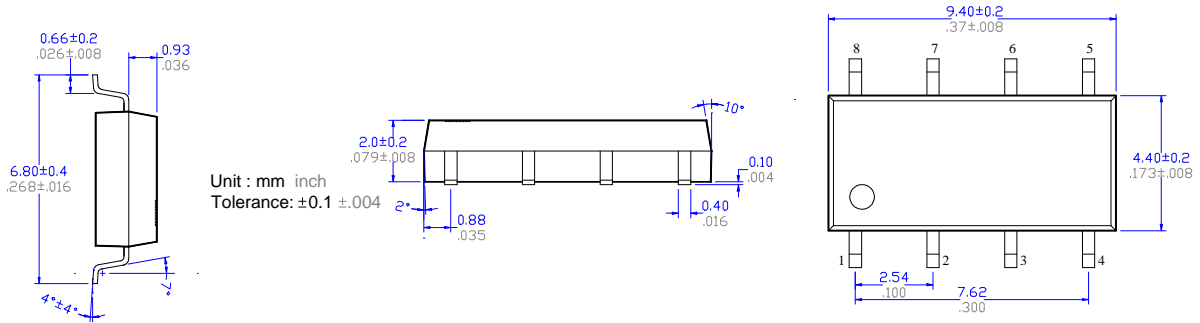

### Recommended mounting pad (TOP VIEW)

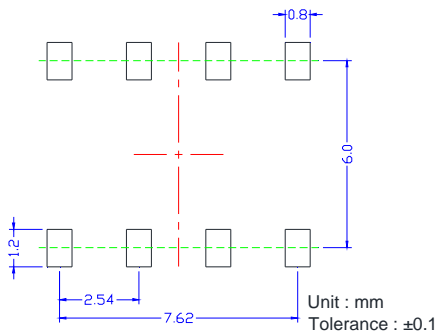

### Marking

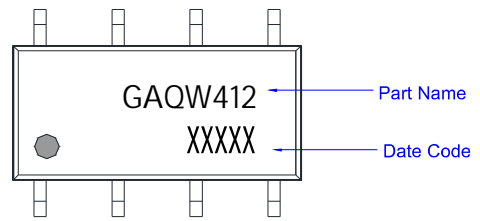

### Tape dimensions

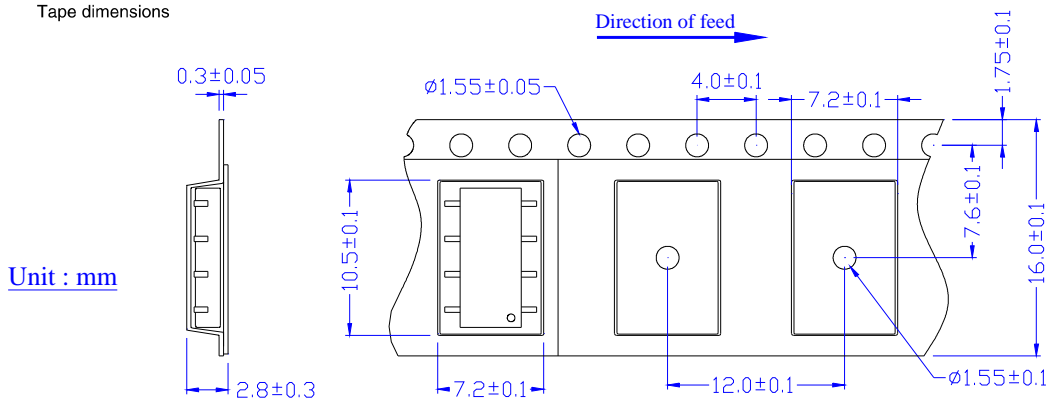

### Dimensions of tape reel

