

TOBILED[®]

2024



No.5 building, Qingwan industrial zone, Sanzao Town, Jinwan District,
Zhuhai City, Guangdong province, China, 519040

Contact No.: 0086-756-6805251/6805252/6805253/6805254/
6805465/6805310;

Email: info@tobiled.com www.tobiled.com Fax: 0086-756-6805559

TOBILED CO., LIMITED ALL rights reserved.
Designs and specifications may change without prior notice.



Outdoor Lighting

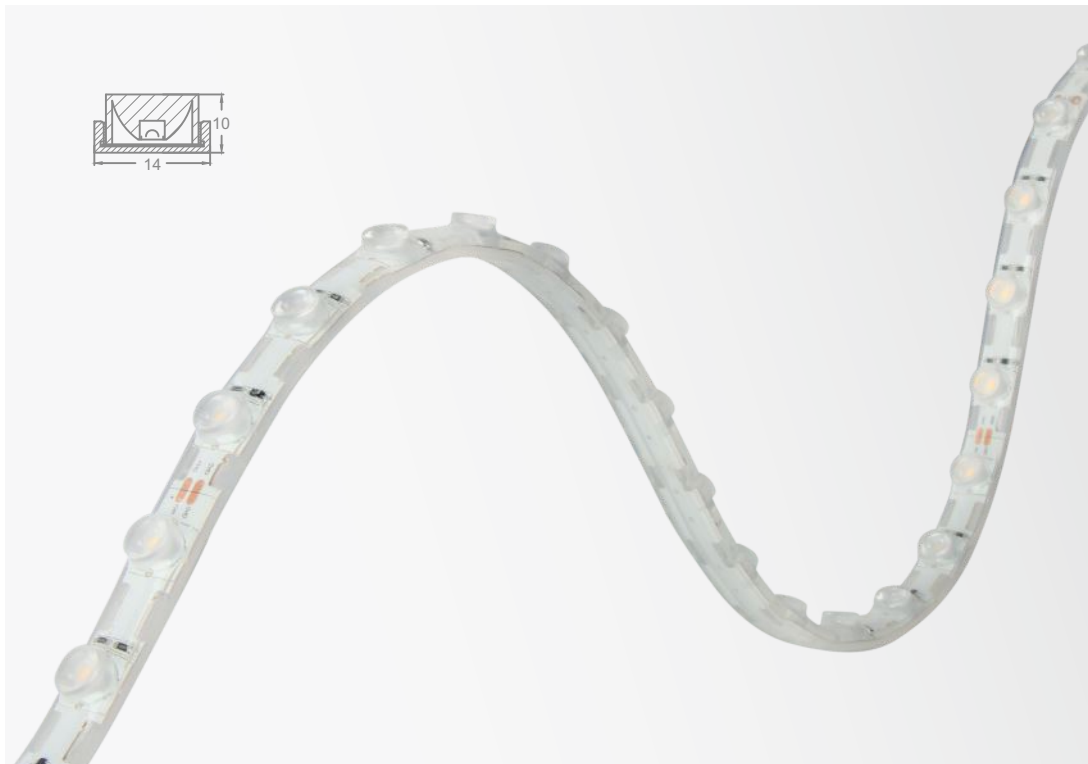



Part No.	Description	Picture	Part No.	Description	Picture
1.05.034.0086 (1M) 1.05.034.0087 (2M) 1.05.034.0088 (3M)	Aluminum profile			Metal end cap	
1.04.03.34.0024 (2.4M)	PMMA clear cover		1.01.07.0080 1.01.05.0030 (M3*16mm)	Stainless steel mounting clip	

FP1405 IP67 Flexible Wall Washer
 Input Voltage:24V DC
 Power:15W/1.06m
 CCT: 2500K/ 2700K/3000K/3500K/4000K
 4500K/5000K/5700K/6500K
 CRI: Ra≥80 or Ra≥90
 Beam angle: 30°/40°/50°/25°X50°
 Maximum 5.088 meters
 Working Temperature:-40°C~+45°C
 Net weight :133g/1.06meter
 The above net weight does not include
 aluminum profiles.

suit for class 2 power unit, we suggest
 maximum connected power not more than 100W



Part No.	Description	Picture
2.02.WW.001	stainless steel holder can be turned around 180°	
1.01.07.0134 1.01.05.0296 (M3*16mm)	bendable stainless steel mounting clip	

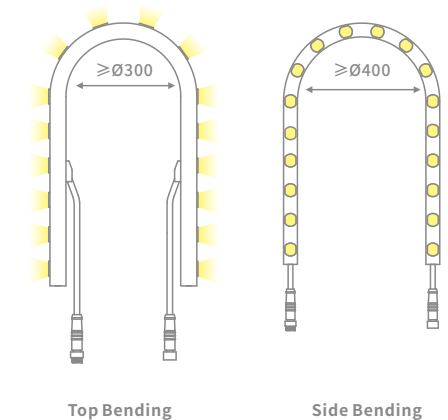

FP06MINI-14 flexible wall washer
 IP rating: IP67
 Input Voltage:24V DC
 Power:15W/1.06m
 Colors: 2700K-6500K
 CRI: Ra ≥90

Maximum 5.088 meters
 Beam angle:25°/45°/15X55°
 Application: suit for commercial lighting,
 wall washing illumination
 Installation: surface mounting
 Working Temperature:-40°C~+45°C
 Net Weight:286g/1.06meter

suit for class 2 power unit, we suggest
 maximum connected power not more than 100W

FP06 IP67 Flexible Wall Washer



FP06AL1



FP06AL1-S

Cutttable flexible wall washer LED strip - IP67
 Input Voltage:24V DC
 Power:19.2W/m(Symmetric),16W/m(Asymmetric)
 Single CCT: 2500K/ 2700K/3000K/3500K/4000K/6500K;
 Tunable white CCT:2700K-6500K;
 DMX control:
 1.DMX single CCT 2500K/ 2700K/3000K/3500K/4000K/6500K;
 2.DMX Tunable white CCT 2700K-6500K;
 3.DMX RGB;
 CRI: Ra≥80 or Ra≥90
 Beam angle: 20°/30°/40°/50°/25° X 40°,70° x 110°(Asymmetric),
 35°/50°/45° X 55°(RGB/RGBW)
 Maximum 5 meters
 Working Temperature:-40°C~+45°C
 Net weight :240g/meter (Symmetric)
 220g/meter (Asymmetric)
 The above net weight does not include aluminum profiles.
 For outdoor application, we suggest to use
 together with aluminum housing for heat release.

suit for class 2 power unit, we suggest maximum
 connected power not more than 100W

Part No.	Description	Picture	Part No.	Description	Picture
1.05.025.0225 (1.046m)	Aluminum profile		2.03.LL.0002	2 PIN Male connection cable	
1.05.025.0224 (2.046m)					
1.05.025.0227 (3.16m)					
1.01.04.25.0004 1.01.05.0277 (M2.6*8mm)	End cap- E1 Self-tapping screws		2.03.LL.0001	2 PIN Male connection cable	
1.01.04.25.0005 1.01.05.0277 (M2.6*8mm)	End cap- E2 Self-tapping screws		2.03.LL.0010	2 PIN Male connection cable from left side	
1.04.02.25.0014 (1.046m)	PC37-30 PC COVER -P1		2.03.LL.0009	2 PIN Male connection cable from right side	
1.04.02.25.0013 (2.046m)					
1.04.02.25.0017 (3.16m)					
1.04.02.25.0007 (3.02m)	FP06-30 PC COVER -P2		2.03.LL.0003	2 PIN join connector	
1.01.07.0091 1.01.05.0030 (M3*16mm)	Stainless steel mounting clip Self-tapping screws		2.03.LL.0012	End cap	
1.01.07.0101 1.01.05.0296 (M3*16mm) 1.01.05.0218 (M3*3mm)	90 degree turnable clip Self-tapping screws		1.11.01.0098	UV glue	
1.13.13.0247	UV light				



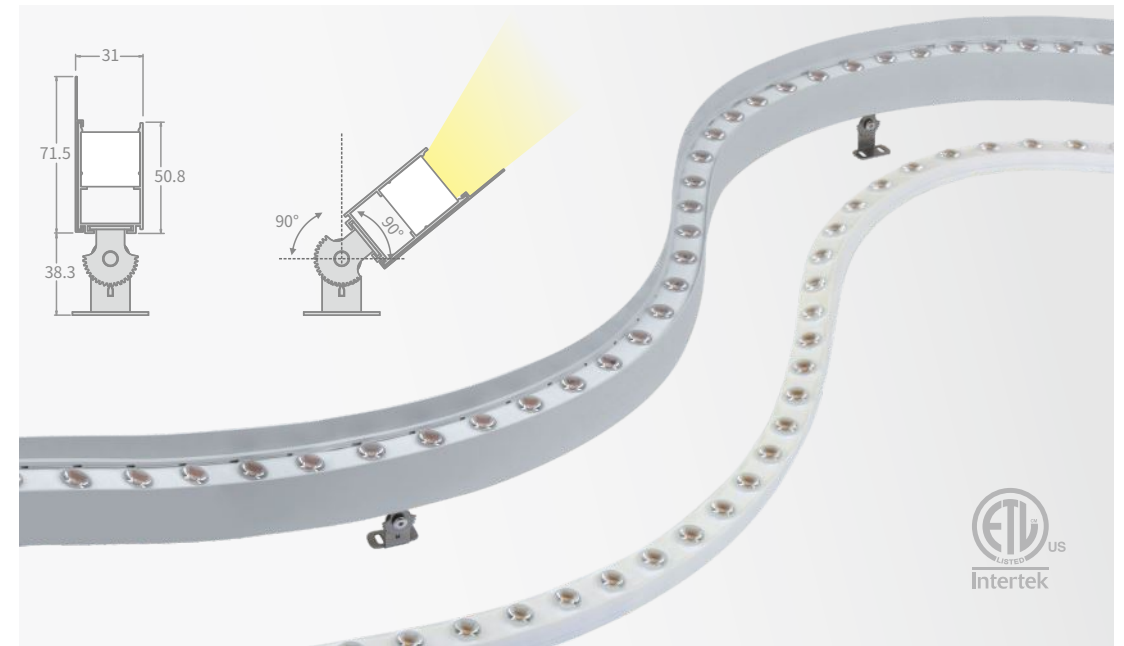

Part No.	Description	Picture
1.01.07.0123 1.01.05.0030 (M3*16mm)	bendable stainless steel mounting clip	
1.01.07.0159 1.01.05.0030 (M3*16mm)	Anti-glare bendable stainless steel mounting clip	

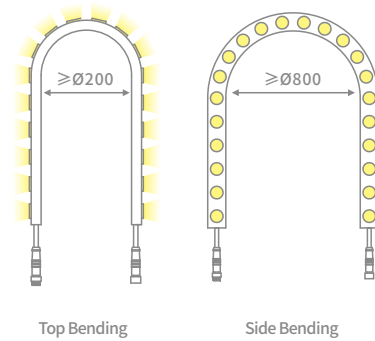

Sealed with fully transparent and waterproof materials, soft and bendable
 IP rating: IP 67
 Input Voltage: 24V
 Power: 19,2W/m
 Colors: 1800K-6000K, RGB,RGBW (DMX)
 CRI: Ra≥80 or Ra≥90
 Beam angle: 20°/30°/40°/55°/25°X40°
 Maximum 5 meters
 Installation: surface mounting
 Maximum: 19.2W/m
 Length: 5000mm/reel
 Working Temperature:-40°C~+45°C
 Net Weight:268g/meter

suit for class 2 power unit, we suggest maximum connected power not more than 100W



Part No.	Description	Picture
1.05.025.0259 1.05.025.0260	bendable Anti-glare aluminium profile	
2.02.WW.005	stainless steel holder can be turned around 180°	
1.01.07.0139 1.01.05.0296 (M3*16mm)	bendable Stainless steel mounting clip	
2.02.WW.002	stainless steel holder can be turned around 180°	

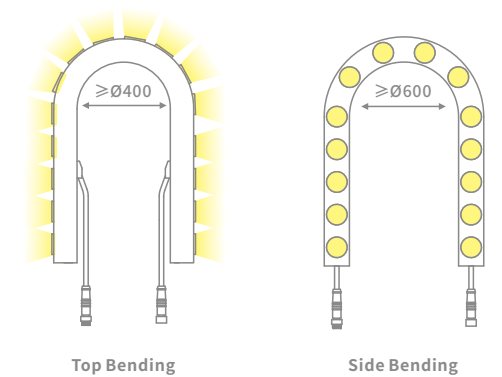

FP06-27 flexible wall washer
 IP rating: IP67
 Input Voltage:24V DC
 Power:30W/m
 Colors: 2700K-6500K, DMX RGBW
 CRI: Ra≥90
 Maximum 4 meters
 Beam angle: 15°/20°/30°/20°×40°/20°×50°
 25°/40°/50°/25 X 45° (RGB/RGBW)
 Application: suit for commercial lighting, wall washing illumination
 Installation: surface mounting
 Working Temperature:-40°C~+45
 Net Weight:865g/meter
 The above net weight does not include aluminum profiles.
 suit for class 2 power unit, we suggest maximum connected power not more than 100W

3D Flex Grazer

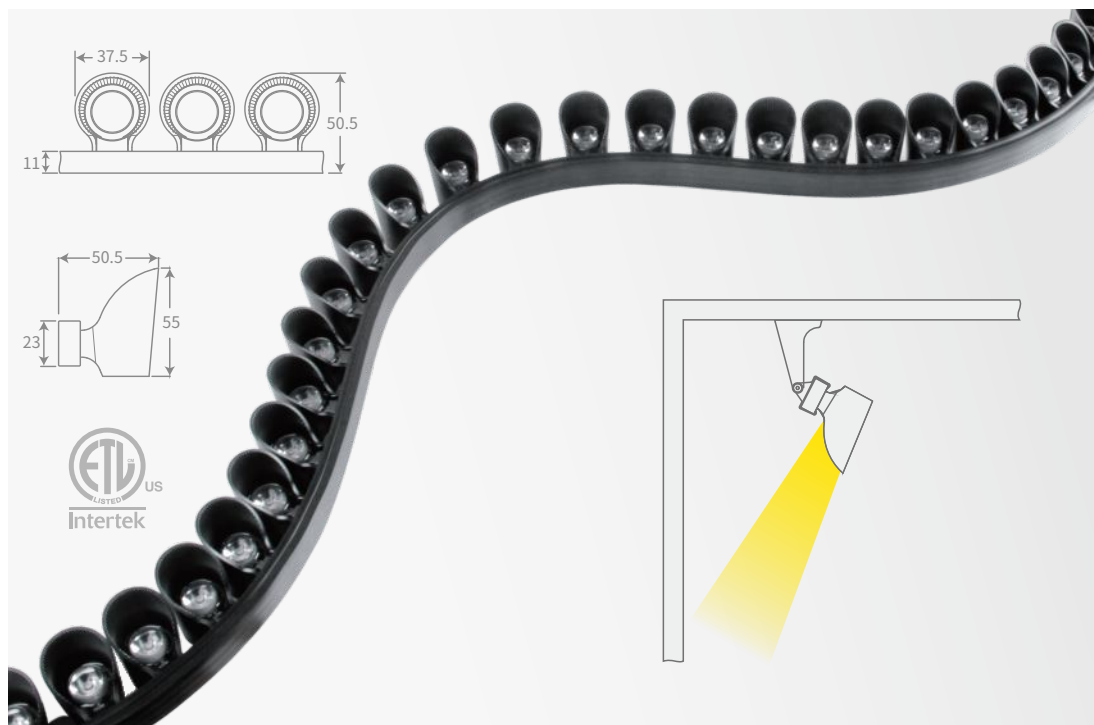

Part No.	Description	Picture	Part No.	Description	Picture
2.02.WW.004	stainless steel holder can be turned around 90°		2.03.ww.007	Stainless steel strap for tree fixing	

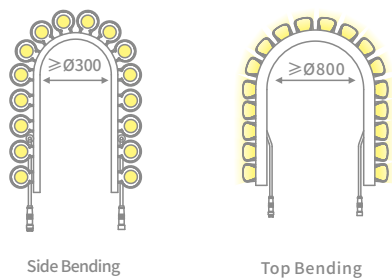

3D Flex Grazer glaring free
 IP67 high power 3D flex LED grazer has been designed with anti-glare housing, flexible, easy to fix, Input Voltage: 24V DC, power:45W in 1200mm length
 45W in 1200mm length (RGB/RGBW)
 Colors: 2700K-6500K, DMX single color /DMX RGBW
 CRI: Ra≥90
 Beam angle :15°/20°/30°/20°×40°/20°×50°
 20°/35°/45°/55°/20 X 45°(RGB/RGBW)
 Maximum 1200mm length
 Working Temperature:-40°C~+45°C
 Net Weight:1048g/1.2meter

suit for class 2 power unit, we suggest maximum connected power not more than 100W



FP01S IP67 Flexible LED Linear Light

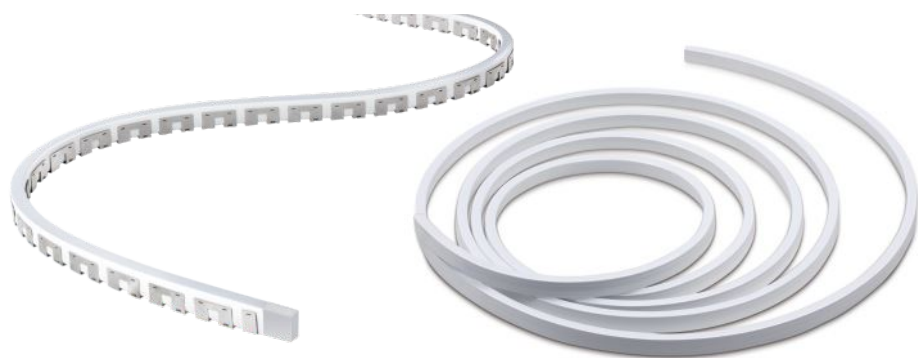
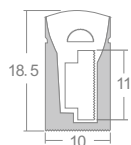

Part No.	Description	Picture	Part No.	Description	Picture
1.16.025.0079 5M 1.16.025.0080 10M 1.16.025.0081 20M	silicone one time extrusion		1.01.07.0035 1.01.05.0030 (M3*16mm)	Stainless steel mounting clip	
1.05.025.0062 (1M)	Aluminum profile W12.05*H21.23mm		1.01.07.0102 (1m) 1.01.07.0103 (5m) 1.01.07.0104 (10m)	stainless steel bendable mounting clip	
1.13.12.0132 (with hole) 1.13.12.0133 (w/o hole)	silicone End Cap				

Flexible LED linear light
 Dimension: W10*H18.5*L1000mm
 (Customized length is available on request.)
 Input voltage:24V DC
 120pcs LED per meter
 Colors: 1800-6500K
 CRI:Ra≥80 or Ra≥90
 Beam Angle: 110°
 (Option : Cable comes from the end, from the bottom)
 IP rating: IP67
 Working Temperature:-40°C~+45°C
 Net Weight:218g/meter
 suit for 6-10mm width LED strip,
 Maximum 10W/m
 maximum 10meter length.

suit for class 2 power unit, we suggest maximum
 connected power not more than 100W





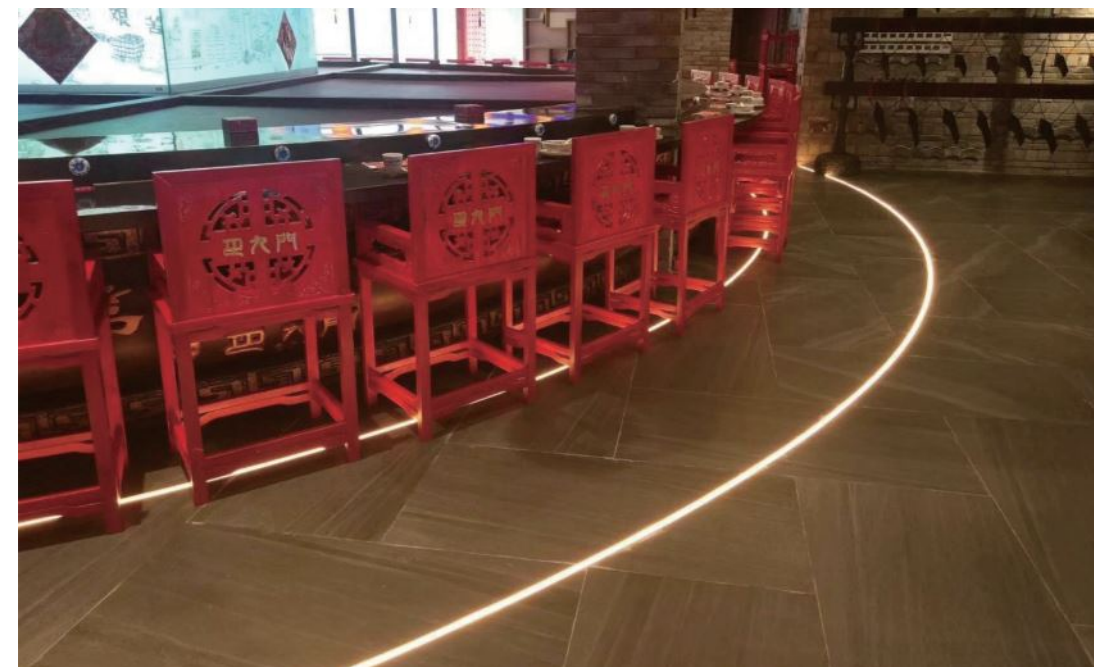

Color Temperature: 2400-6500K

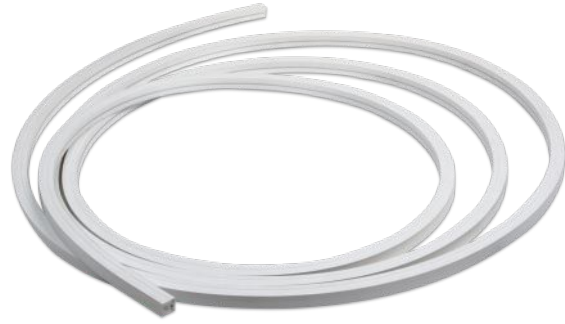
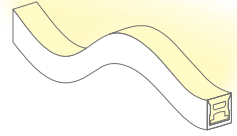
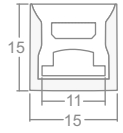

FP07T IP67 Flexible LED Linear Light



Part No.	Description	Picture	Part No.	Description	Picture
1.16.025.0083	silicone profile		1.01.07.0124 1.01.05.0296 (M3*16)	Metal mounting clip	
1.05.025.0235 (1m) 1.05.025.0234 (2m) 1.05.025.0233 (3m)	Aluminum profile		1.02.04.25.0055 (with hole) 1.02.04.25.0054 (w/o hole)	Silicon end cap	

Flexible Led linear light
 Size: W15*H15*L1000mm
 Voltage: 24V
 Power: 10W/meter
 120pcs LED / meter
 Colors : 1800K-6500K, RGB
 Beam angle: 110°
 CIR: Ra≥80 or Ra≥ 90
 IP rating: IP67
 Working Temperature:-40°C~+45°C
 Net Weight:249g/meter
 Fire rating : V2
 suit for 6mm/8mm/10mm width LED strip,

suit for class 2 power unit,we suggest maximum connected power not more than 100W

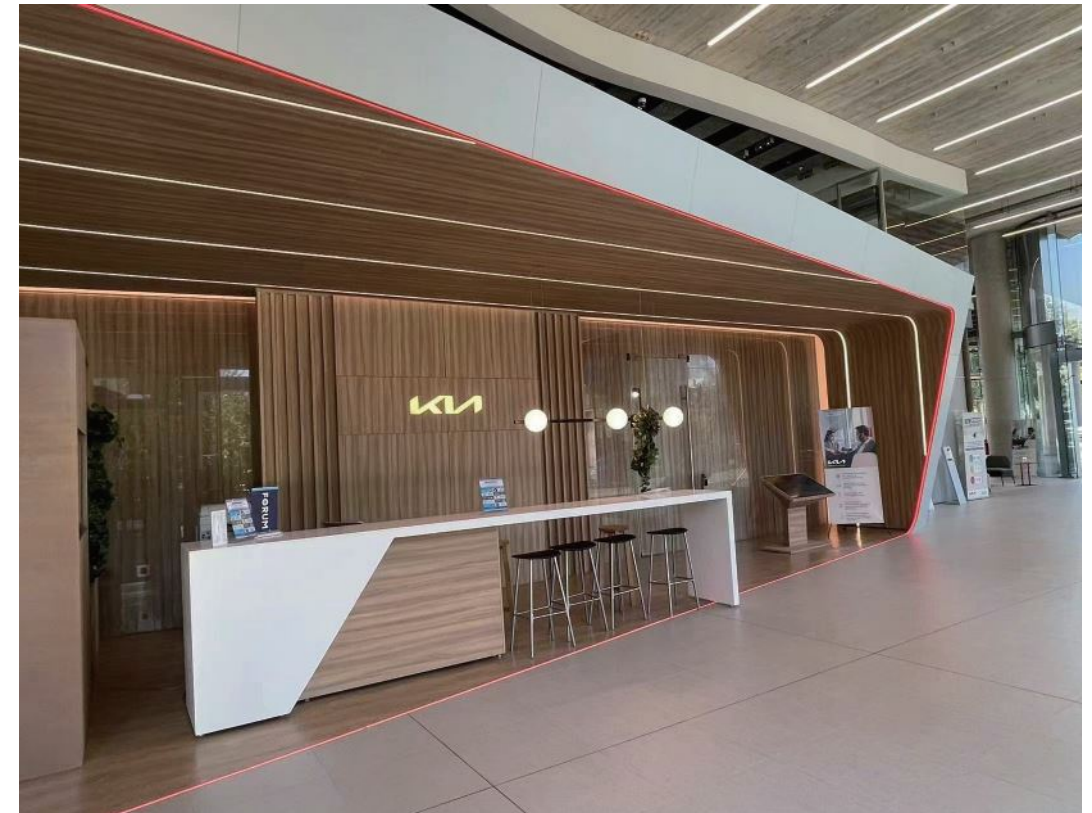
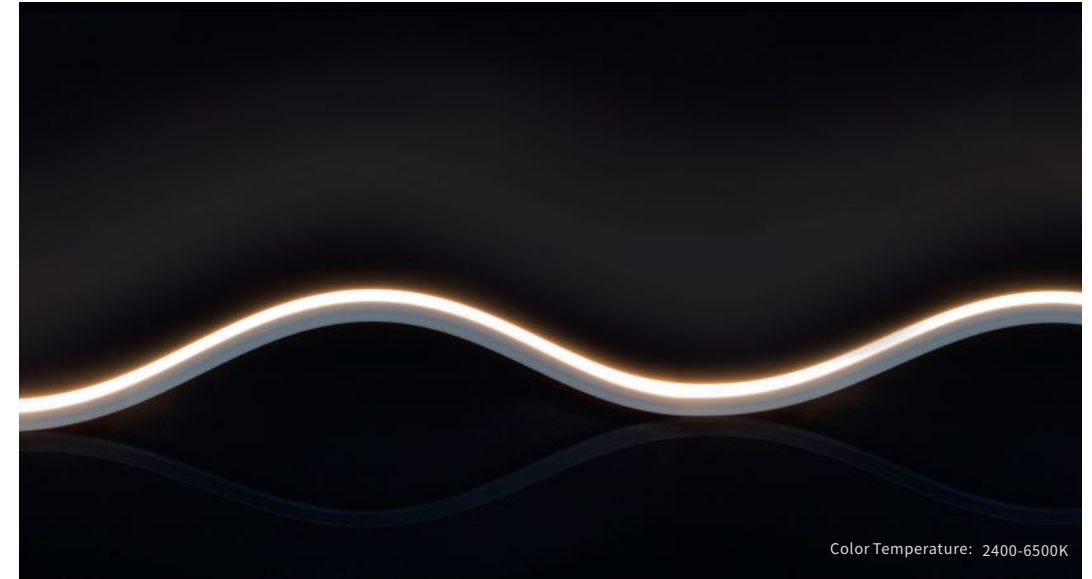

FP07S IP67 Flexible LED Linear Light

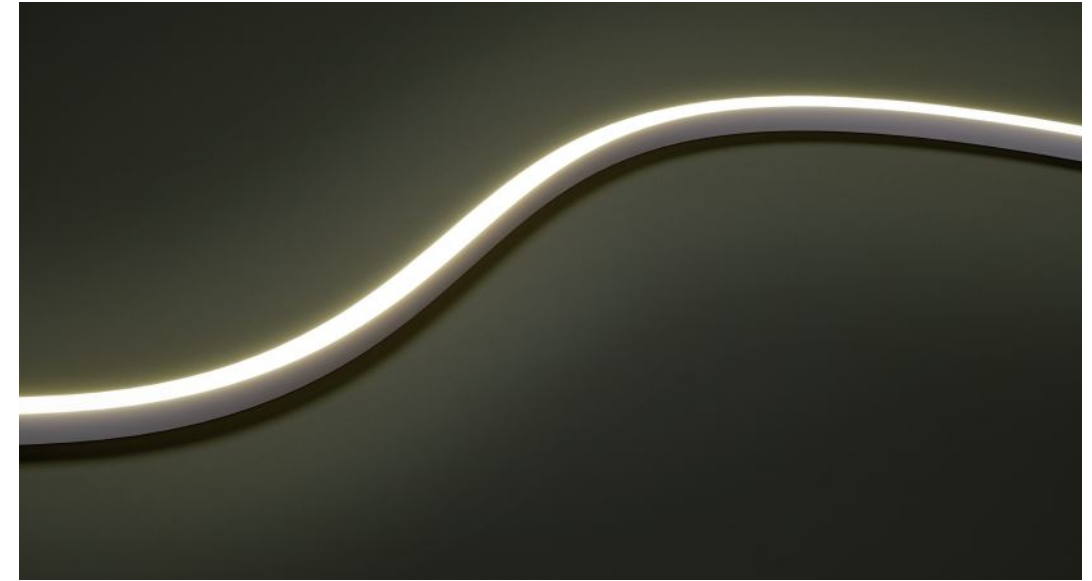
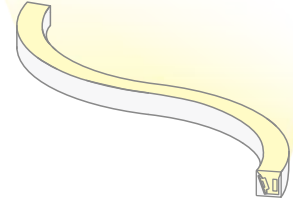
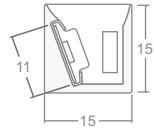

Part No.	Description	Picture	Part No.	Description	Picture
1.16.025.0084	silicone profile		1.01.07.0124 1.01.05.0296 (M3*16)	Metal Mounting clip	
1.05.025.0235 (1m) 1.05.025.0234 (2m) 1.05.025.0233 (3m)	Aluminum profile		1.02.04.25.0055 (with hole) 1.02.04.25.0054 (w/o hole)	Silicon end Cap	

Flexible Led linear light

Size: W15*H15*L1000mm

Voltage: 24V

Power: 10W/meter

120pcs LED / meter

Colors : 1800K-6500K

Beam angle: 110°

CRI:Ra≥80 or Ra≥ 90

IP rating: IP67

Working Temperature:-40°C~+45°C







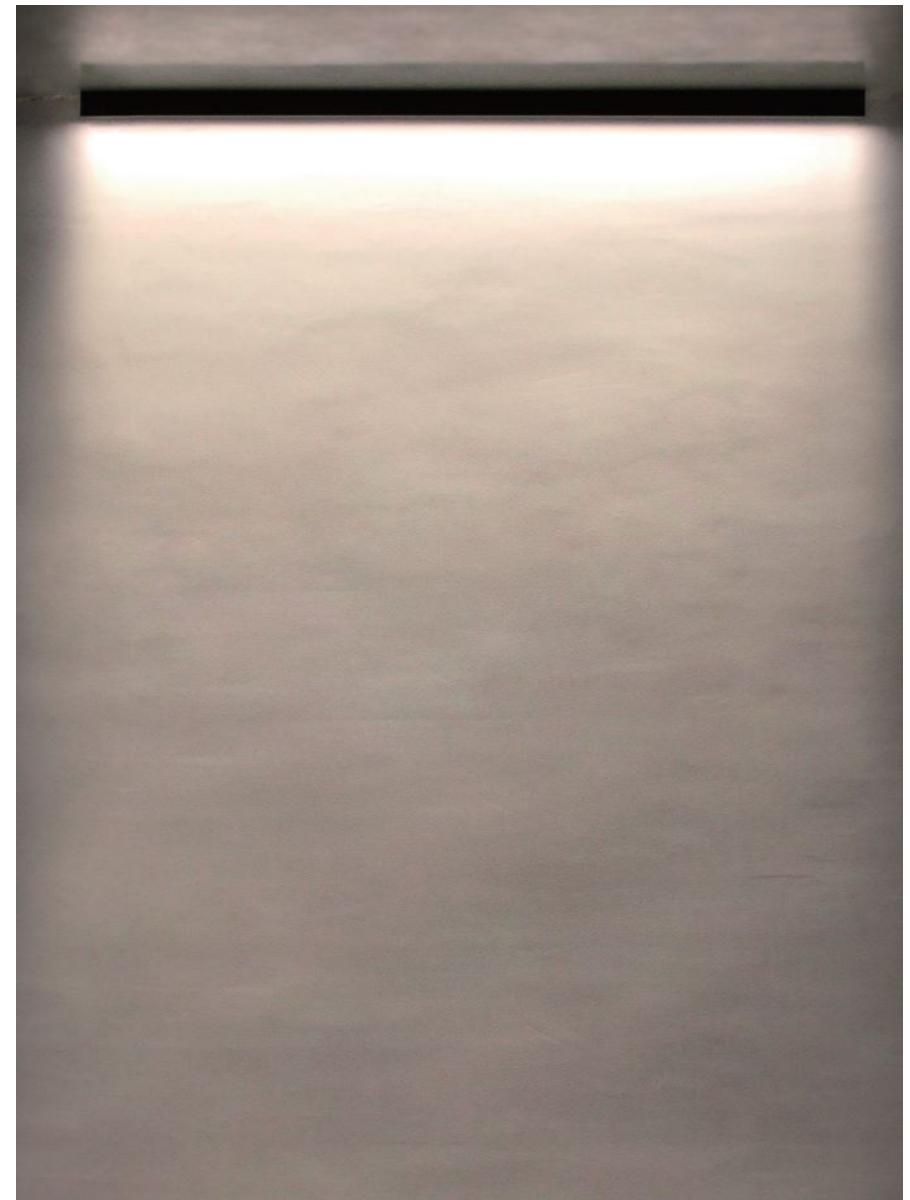
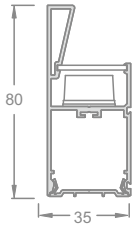

Net Weight:249g/meter

Fire rating : V2

suit for 6mm/8mm/10mm width LED strip,

suit for class 2 power unit, we suggest maximum connected power not more than 100W



Part No.	Description	Picture	Part No.	Description	Picture
1.05.035.0123 (1.2m)	Aluminum profile		1.05.035.0124 (1.2m) 1.01.05.0030 (M3*16mm)	Aluminium clip plate	
1.04.02.35.0026 (1.2m)	PC cover		1.01.04.35.0033 (Left) 1.01.04.35.0034 (right)	Metal end cap	
1.01.06.0033	Rope system for hang up, 3 meter length (for hang up application)		1.09.04.0115	Led Power supply	
1.01.08.0157	safety rope (for ceiling and suspending application)		2.02.LL.001	stainless steel adjustable holder can be turned around 160°	
1.01.06.0080	Waterproof Connectors				

Dimension: L1200/2400*W35*H80mm
 (Customized length is available on request.)
 Input voltage:24V DC
 Power: 32W/1200mm
 Beam Angle:15°/20°/18°× 45°/18°× 55°
 Colors: 2700-6500K, DMX single color, DMX RGBW
 CRI:Ra≥90
 Working Temperature:-40°C~+45°C
 Dimming function:
 (0-10V DC or PWM signal)
 Led Power supply to be purchased separately
 IP rating: IP 20 or IP 67

Installation method

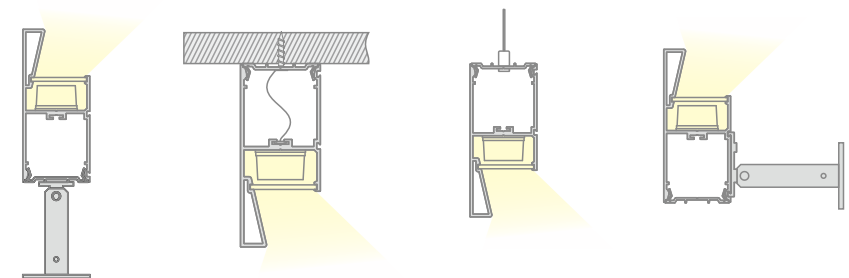

WP02AL1 (AP0501AL1) IP67 LED Linear Light



Part No.	Description	Picture	Part No.	Description	Picture
1.05.005.0014 (1m) 1.05.005.0015 (2m) 1.05.005.0016 (3m)	Aluminum profile		1.02.04.05.0014 (with hole) 1.02.04.05.0015 (w/o hole)	PC End cap	
1.16.005.0040 (1m) 1.16.005.0041 (2m) 1.16.005.0042 (3m)	PMMA one time extrusion profile		1.05.005.0040 1m 1.05.005.0041 2m 1.05.005.0042 3m	Aluminum plate	
1.11.01.0079	EPOXY ADHESIVE				

Walkable LED linear light
 Dimension: W20.2*H16.2*L1000mm
 (Customized length is available on request.)
 Input voltage:24V DC
 Power: 10W/meter
 120pcs LED per meter
 Colors: 1800-6500K
 CRI:Ra≥80 or Ra≥90
 Beam Angle: 110°
 Cable length: 200mm
 (Option : Cable comes from the side,from the end,from the bottom)
 IP rating: IP67
 Working Temperature:-40°C~+45°C
 Net Weight:451g/meter
 Fire rating:HB
 IK10

Suit for class 2 power unit, we suggest maximum connected power not more than 100W

WP02AL3 (AP0501AL3) IP67 LED Linear Light









Part No.	Description	Picture	Part No.	Description	Picture
1.05.005.0206 (1m) 1.05.005.0207 (2m) 1.05.005.0208 (3m)	Aluminum profile		1.02.04.05.0014 (with hole) 1.02.04.05.0015 (w/o hole)	End cap PC white	
1.16.005.0040 (1m) 1.16.005.0041 (2m) 1.16.005.0042 (3m)	PMMA one time extrusion profile		1.01.04.05.0001 1.01.05.0356 (M2.6*10)	Metal end cap	
1.11.01.0079	EPOXY ADHESIVE		1.05.005.0040 1m 1.05.005.0041 2m 1.05.005.0042 3m	Aluminum plate	

IP67 Walkable LED linear light
 Dimension: W36.4*H35*L1000mm
 (Customized length is available on request.)
 Input voltage:24V DC
 Power: 10W/meter
 120pcs LED per meter
 Colors: 1800-6500K
 CRI:≥80 or ≥90
 Beam Angle: 110°
 Cable length: 200mm
 (Option: Cable comes from the side,from the end,from the bottom)
 IP rating: IP67
 Working Temperature:-40°C~+45°C
 Net Weight:750g/meter
 Fire rating:HB
 IK10

suit for class 2 power unit, we suggest maximum connected power not more than 100W

WP02AL4 (AP0501AL4) IP67 LED Linear Light



Part No.	Description	Picture	Part No.	Description	Picture
1.05.005.0280 (1m)	Aluminum profile		1.05.005.0040 1m	Aluminum plate	
1.05.005.0281 (2m)			1.05.005.0041 2m		
1.05.005.0282 (3m)			1.05.005.0042 3m		
1.16.005.0040 (1m)	PMMA one time extrusion profile		1.11.01.0079	EPOXY ADHESIVE	
1.16.005.0041 (2m)					
1.16.005.0042 (3m)					
1.02.04.05.0014 (with hole)	Plastic end cap		1.01.04.05.0015	Metal end cap	
1.02.04.05.0015 (w/o hole)			1.01.05.0356 (M2.6*10)		

Walkable LED linear light

Dimension: W20.4*H29.8*L1000mm

(Customized length is available on request.)

Input voltage: 24V DC

Power: 10W/meter

120pcs LED per meter

Colors: 1800-6500K

CRI: Ra \geq 80 or Ra \geq 90

Beam Angle: 110°

Cable length: 200mm

(Option : Cable comes from the side, from the end, from the bottom)

IP rating: IP67

Working Temperature: -40°C~+45°C

Net Weight: 597g/meter

Fire rating: HB

IK10

Suit for class 2 power unit, we suggest maximum connected power not more than 100W

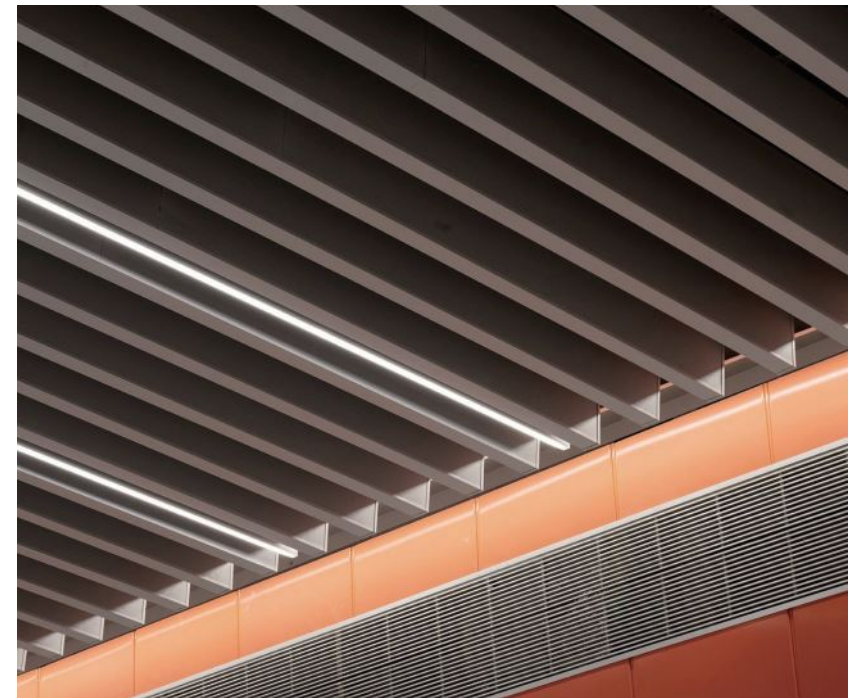

WP03AL1 (AP0502AL1) IP67/IP68 LED Linear Light

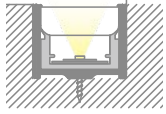
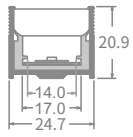

Part No.	Description	Picture	Part No.	Description	Picture
1.05.015.0014 (1m) 1.05.015.0015 (2m) 1.05.015.0016 (3m)	Aluminum profile		1.02.04.15.0019 (with hole) 1.02.04.15.0020 (w/o hole)	Frosted end cap	
1.16.005.0056 (1m) 1.16.005.0057 (2m) 1.16.005.0058 (3m)	PMMA one time extrusion profile		1.05.015.0034 1m 1.05.015.0036 2m 1.05.015.0037 3m	Aluminum plate	
1.11.01.0079	EPOXY ADHESIVE				

Walkable LED linear light
 Dimension: W24.7*H20.7*L1000mm
 (Customized length is available on request.)
 Input voltage:24V DC
 Power: 15W/meter
 120pcs LED per meter
 Colors: 1800-6500K, DMX RGBW
 CRI:Ra≥80 or Ra≥90
 Beam Angle: 110°
 Cable length: 200mm
 (Option : Cable comes from the side,from the end,from the bottom)
 IP rating: IP67/IP68 can be used in swimming pool
 Working Temperature:-40°C~+45°C
 Net Weight:588g/meter
 Fire rating:HB
 IK10

Suit for class 2 power unit, we suggest maximum connected power not more than 100W

WP03AL2 (AP0502AL2) IP67/IP68 LED Linear Light

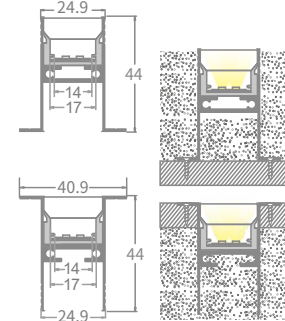

Part No.	Description	Picture	Part No.	Description	Picture
1.05.015.0051 (1m) 1.05.015.0052 (2m) 1.05.015.0053 (3.05m)	Aluminum profile		1.05.015.0034 1m 1.05.015.0036 2m 1.05.015.0037 3m	Aluminum plate	
1.16.005.0056 (1m) 1.16.005.0057 (2m) 1.16.005.0058 (3m)	PMMA one time extrusion profile		1.02.04.15.0019 (with hole) 1.02.04.15.0020 (w/o hole)	Frosted end cap	
1.11.01.0079	EPOXY ADHESIVE		1.01.04.05.0013 1.01.05.0345 (M3*10)	Metal end cap	

Walkable LED linear light
 Dimension: W40.9*H44*L1000mm
 (Customized length is available on request.)
 Input voltage:24V DC
 Power: 15W/meter
 120pcs LED per meter
 Colors: 1800-6500K, DMX RGBW
 CRI:≥80 or ≥90
 Beam Angle: 110°
 Cable length: 200mm
 (Option : Cable comes from the side,from the end,from the bottom)
 IP rating: IP67/IP68 can be used in swimming pool
 Working Temperature:-40°C~+45°C
 Net Weight:959g/meter
 Fire rating:HB
 IK10

Suit for class 2 power unit, we suggest maximum connected power not more than 100W

WP03AL3 (AP0502AL3) IP67/IP68 LED Linear Light



Part No.	Description	Picture	Part No.	Description	Picture
1.05.015.0325 (1m)	Aluminum profile		1.02.04.15.0019 (with hole)	Frosted end cap	
1.05.015.0324 (2m)			1.02.04.15.0020 (w/o hole)		
1.05.015.0323 (3.05m)					
1.16.005.0056 (1m)	PMMA one time extrusion profile		1.05.015.0034 1m	Aluminum plate	
1.16.005.0057 (2m)			1.05.015.0036 2m		
1.16.005.0058 (3m)			1.05.015.0037 3m		
1.11.01.0079	EPOXY ADHESIVE		1.01.04.05.0024	Metal end cap	
			1.01.05.0345 (M3*10)		

Walkable LED Linear light
 Dimension: W24.9*H44*L1000mm
 (Customized length is available on request.)
 Input voltage: 24V DC
 Power: 15W/meter
 120pcs LED per meter
 Colors: 1800-6500K, DMX RGBW
 CRI: Ra \geq 80 or Ra \geq 90
 Beam Angle: 110°
 Cable length: 200mm
 (Option : Cable comes from the side, from the end, from the bottom)
 IP rating: IP67/IP68 can be used in swimming pool
 Working Temperature: -40°C~+45°C
 Net Weight: 850g/meter
 Fire rating: HB
 IK10

Suit for class 2 power unit, we suggest maximum connected power not more than 100W



WP04AL4 (AP0503AL4) IP67/IP68 LED Linear Light



Part No.	Description	Picture	Part No.	Description	Picture
1.05.005.0265 (1m) 1.05.005.0266 (2m) 1.05.005.0267 (3m)	Aluminum profile		1.05.005.0050 1m 1.05.005.0051 2m 1.05.005.0052 3m	Aluminum plate	
1.16.005.0045 (1m) 1.16.005.0046 (2m) 1.16.005.0047 (3m)	PMMA one time extrusion profile		1.11.01.0079	EPOXY ADHESIVE	
1.05.005.0190	Aluminum plate		1.02.04.05.0042 (with hole) 1.02.04.05.0043 (w/o hole)	Plastic end cap	

Walkable LED linear light
 Dimension: W30.6*H30*L1000mm
 (Customized length is available on request.)
 Input voltage:24V DC
 Power: 20W/meter
 240pcs LED per meter
 Colors: 1800-6500K,DMX RGBW
 CRI:Ra≥80 or Ra≥90
 Beam Angle: 110°
 Cable length: 200mm
 (Option : Cable comes from the side,from the end,from the bottom)
 IP rating: IP67/IP68 can be used in swimming pool
 Working Temperature:-40°C~+45°C
 Net Weight:1014g/meter
 Fire rating:HB
 IK10

Suit for class 2 power unit, we suggest maximum connected power not more than 100W

WP04AL2 (AP0503AL2) IP67/IP68 LED Linear Light



Part No.	Description	Picture	Part No.	Description	Picture
1.05.005.0181 (1m) 1.05.005.0182 (2m) 1.05.005.0197 (3m)	Aluminum profile		1.05.005.0190	Aluminum plate	
1.16.005.0045 (1m) 1.16.005.0046 (2m) 1.16.005.0047 (3m)	PMMA one time extrusion profile		1.05.005.0050 1m 1.05.005.0051 2m 1.05.005.0052 3m	Aluminum plate	
1.11.01.0079	EPOXY ADHESIVE		1.11.01.0079	EPOXY ADHESIVE	
1.01.04.05.0014 1.01.05.0345 (M3*10)	Metal end cap		1.02.04.05.0042 (with hole) 1.02.04.05.0043 (w/o hole)	Plastic end cap	

Walkable LED linear light
 Dimension: W55.6*H63.7*L1000mm
 (Customized length is available on request.)
 Input voltage:24V DC
 Power: 20W/meter
 240pcs LED per meter
 Colors: 1800-6500K, DMX RGBW
 CRI:≥80
 (CRI more than 80 is available on request)
 Beam Angle: 110°
 Cable length: 200mm
 (Option : Cable comes from the side,from the end,from the bottom)
 IP rating: IP67/IP68
 Working Temperature:-40°C~+45°C
 Net Weight:1822g/meter
 Fire rating:HB
 Application: suit for indoor or outdoor light decoration
 can be used in swimming pool

suit for class 2 power unit,we suggest maximum connected power not more than 100W

WP04AL3 (AP0503AL3) IP67/IP68 LED Linear Light



Part No.	Description	Picture	Part No.	Description	Picture
1.05.005.0251 (1m) 1.05.005.0252 (2m) 1.05.005.0253 (3m)	Aluminum profile		1.05.005.0050 1m 1.05.005.0051 2m 1.05.005.0052 3m	Aluminum plate	
1.16.005.0045 (1m) 1.16.005.0046 (2m) 1.16.005.0047 (3m)	PMMA one time extrusion profile		1.11.01.0079	EPOXY ADHESIVE	
1.05.005.0195 (1m) 1.05.005.0194 (2m)	Aluminum plate		1.02.04.05.0042 (with hole) 1.02.04.05.0043 (w/o hole)	Plastic end cap	
1.01.04.05.0017 1.01.05.0345 (M3*10)	Metal end cap				

Walkable LED linear light
 Dimension: W30.6*H45*L1000mm
 (Customized length is available on request.)
 Input voltage: 24V DC
 Power: 20W/meter
 240pcs LED per meter
 Colors: 1800-6500K, DMX RGBW
 CRI: Ra ≥ 80 or Ra ≥ 90
 Beam Angle: 110°
 Cable length: 200mm
 (Option : Cable comes from the side, from the end, from the bottom)
 IP rating: IP67/IP68 can be used in swimming pool
 Working Temperature: -40°C~+45°C
 Net Weight: 1205g/meter
 Fire rating: HB
 IK10

suit for class 2 power unit, we suggest maximum connected power not more than 100W

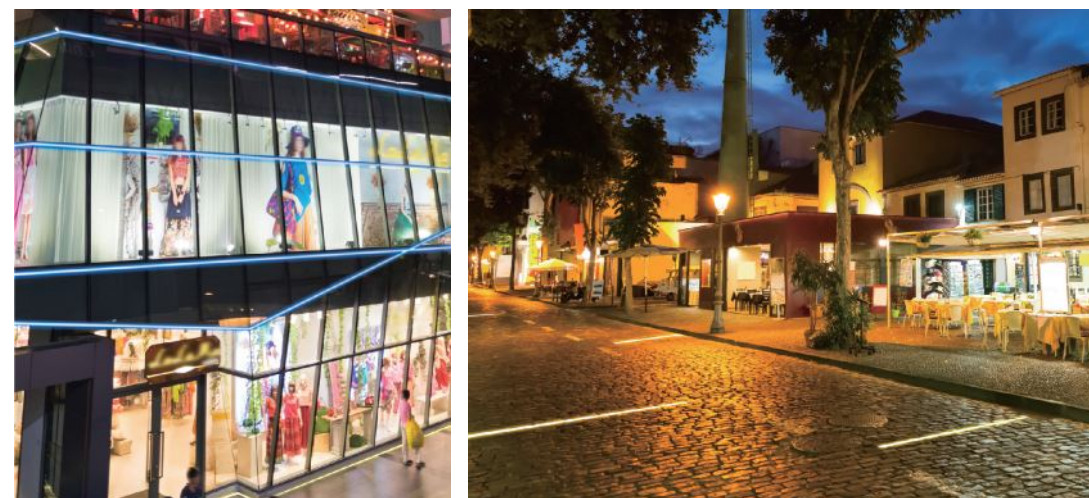

WP10AL2-NEW IP67/IP68 LED Linear Light

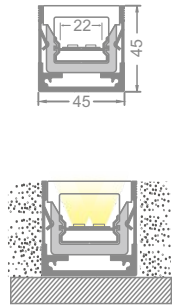

Part No.	Description	Picture	Part No.	Description	Picture
1.05.060.0022 (1M) 1.05.060.0021 (2M)	Aluminum profile		1.05.060.0030 (1M) 1.05.060.0031 (2M)	Aluminum plate	
1.16.060.0005 (3.2M)	PMMA one time extrusion profile		1.02.04.60.0006	Plastic end cap	
1.01.04.60.0002 1.01.05.0345 (M3*10)	Metal end cap				

Walkable LED linear light
 Dimension: W45*H45*L1000mm
 (Customized length is available on request.)
 Input voltage:24V DC
 Power :30W/meter
 240pcs LED per meter
 Colors: 1800-6500K, DMX RGBW
 CRI:Ra≥80 or Ra≥90
 Beam Angle: 120°
 Cable length: 200mm
 (Option : Cable comes from the end, from the bottom)
 IP rating: IP67/IP68 can be used in swimming pool
 Working Temperature:-40°C~+45°C
 Net Weight:1987g/meter
 Fire rating:HB
 IK10

Suit for class 2 power unit, we suggest maximum connected power not more than 100W

WP10AL1-NEW IP67/IP68 LED Linear Light

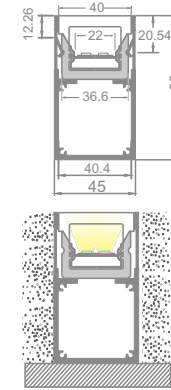

Part No.	Description	Picture	Part No.	Description	Picture
1.05.060.0017 (1M) 1.05.060.0018 (2M) 1.05.060.0019 (3.02M)	Aluminum profile		1.05.060.0030 (1M) 1.05.060.0031 (2M)	Aluminum plate	
1.16.060.0005 (3.2M)	PMMA one time extrusion profile		1.02.04.60.0006	Plastic end cap	
1.01.04.60.0001 1.01.05.0345 (M3*10)	Metal end cap				



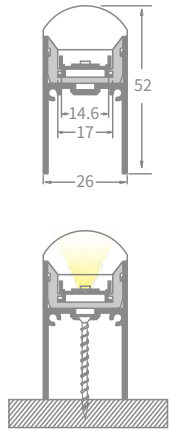

Walkable LED linear light
 Dimension: W45*H80*L1000mm
 (Customized length is available on request.)
 Input voltage:24V DC
 Power :30W/meter
 240pcs LED per meter
 Colors: 1800-6500K, DMX RGBW
 CRI:≥80 or ≥90
 Beam Angle: 120°
 Cable length: 200mm
 (Option : Cable comes from the end, from the bottom)
 IP rating: IP67/IP68 can be used in swimming pool
 Working Temperature:-40°C~+45°C
 Net Weight:2437g/meter
 Fire rating:HB
 IK10

Suit for class 2 power unit, maximum connected power not more than 100W

AP2624 IP67 LED Linear Light



Not For Cyprus And Greece Market

Part No.	Description	Picture	Part No.	Description	Picture
1.05.026.0006 (1.22m)	Aluminum profile		1.05.026.0011 1.21m	Aluminum plate	
1.05.026.0010 (2.02m)			1.05.026.0015 2.01m		
1.16.026.0001 (1.22m)	PMMA one time extrusion profile		1.01.04.26.0003	Metal end cap	
1.16.026.0005 (2.02m)			1.01.05.0345 (M3*10)		
1.02.04.15.0019 (with hole)	Frosted end cap				
1.02.04.15.0020 (w/o hole)					

LED linear light
 Dimension: W26*H52*L1000mm
 (Customized length is available on request.)
 Input voltage: 24V DC
 Power: 15W/meter
 120pcs LED per meter
 Colors: 1800-6500K
 CRI: Ra ≥ 80 or Ra ≥ 90
 Beam Angle: 130°
 Cable length: 200mm
 IP rating: IP67
 Working Temperature: -40°C~+45°C
 Net Weight: 1040g/meter
 Fire rating: HB
 IK10

Suit for class 2 power unit, we suggest maximum connected power not more than 100W



Flexible Silicon Fabric LED Rope



Part No.	Description	Picture	Part No.	Description	Picture
	White Braided Silicone One Time Extrusion			COB LED Strip	
	Black Braided Silicone One Time Extrusion			Metal end cap	
	Red Braided Silicone One Time Extrusion				

Suitable for outdoor and indoor decoration
 Maximum 5 meter length
 24V, ra≥90 or 95, Anti-glare design
 Power: FPS2022:10W/m
 FPS2527:10W/m
 FPS3134:10W/m
 IP67 /Rohs/CE
 Fabric material: Nylon
 Fabric color: white/black/red/customized color
 Suit for class 2 power unit, we suggest maximum connected power not more than 100W

MODEL	STRIP	END CAP
FPS2022		
FPS2527		
FPS3134		

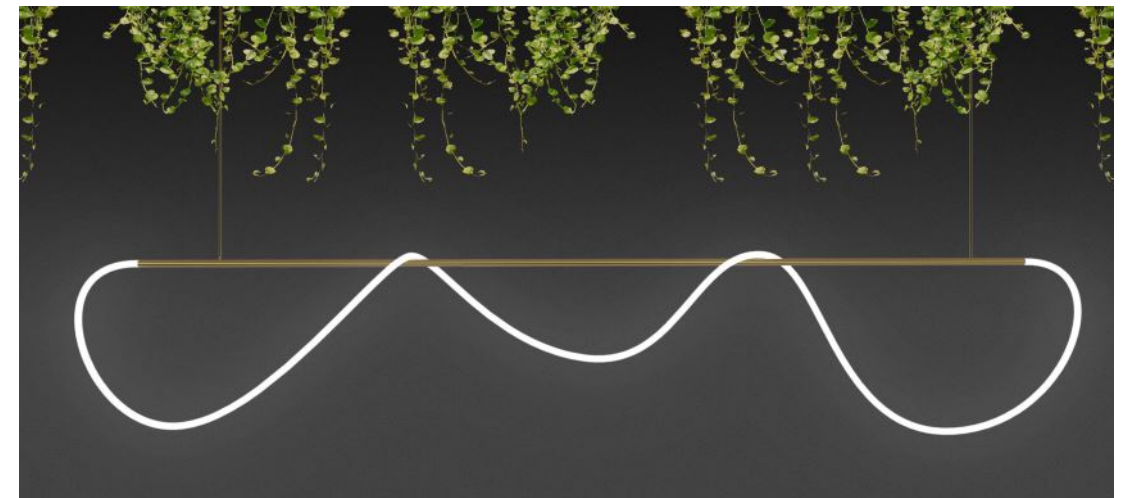

HD42 LED Handrail Light System

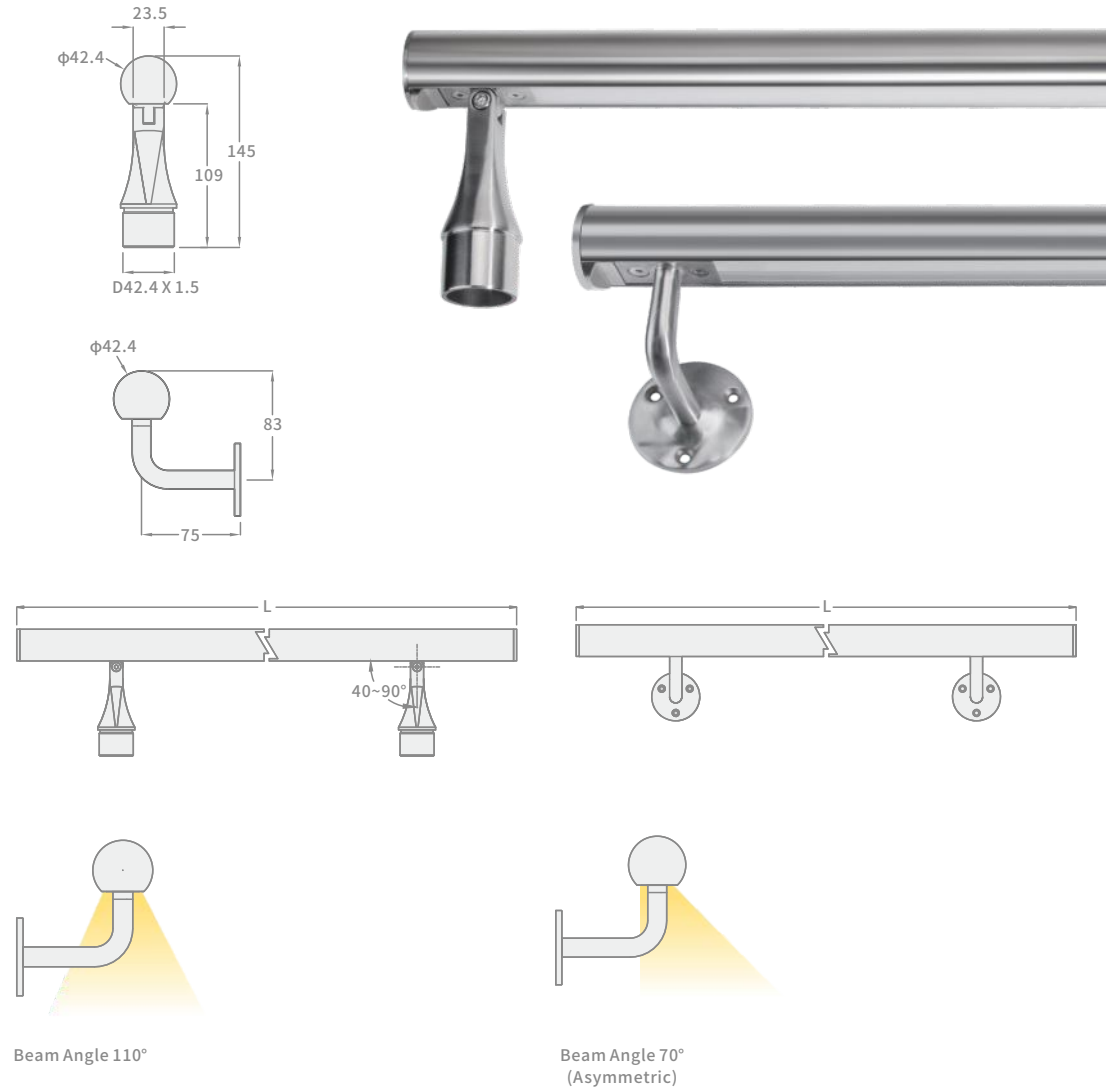

Part No.	Description	Picture	Part No.	Description	Picture
1.05.099	D42.4 handrail		1.05.099 1.01.05.0362 (Self-tapping screws)	Al profile	
1.04.02.98	Diffuser		1.04.02.98	Asymmetric diffuser	
9.0163 Suitable for 10MM width LED Strip	IP65 LED strip		1.03.01.0499	End cap B for LED strip	
2.02.HL.002	standing holder		2.02.HL.003	wall mounting holder	
1.01.08.0152	90 degree connector		1.01.08.0145	turn round connector	
1.01.08.0143	straight connector		1.01.08.0149	turn round connector	
1.01.04.99.0028	Handrail end cap		1.01.08.0150	turn round connector	

M18 LED Handrail Light

M20 LED Handrail Light

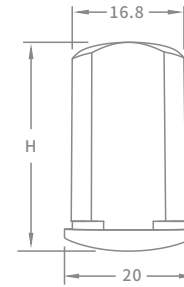
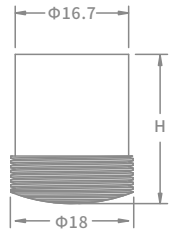

Model	Beam Angle	Dimension	Input Voltage	Power	Net Weight
M18	30°/55°	φ18 X H20mm	3V DC	1W	
M18	ASymmetric-55°	φ18 X H26mm	3V DC	1W	19g
M18	30°/55°	φ18 X H26mm	24V DC	1.2W	19g
M18	ASymmetric-55°	φ18 X H30mm	24V DC	1.2W	20g

Model	Beam Angle	Dimension	Input Voltage	Power	Net Weight
M20	30°/55°	φ20 X H26mm	3V DC	1.5W	30g
M20	ASymmetric-55°	φ20 X H30mm	3V DC	1.5W	30g
M20	30°/55°	φ20 X H26mm	24V DC	1.2W	30g
M20	ASymmetric-55°	φ20 X H30mm	24V DC	1.2W	30g

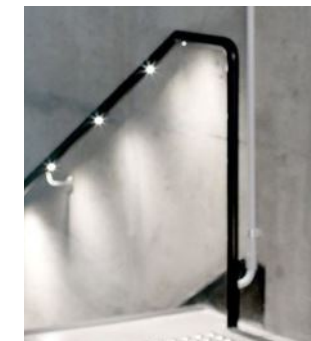
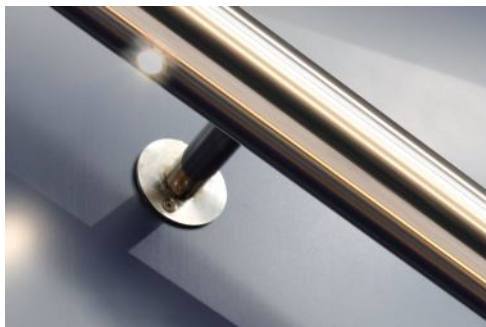

M18 LED handrail light
 Suit for Ø38-100mm handrail with wall thickness >1.5mm for a M18 hole.
 colors from 2700- 6500K and blue for LEDs are available, IP67 waterproof.
 Can be driven by 12V and 24V LED power supply.

suit for class 2 power unit, we suggest maximum connected power not more than 100W

M20 LED handrail lighting
 Stainless steel housing,
 the built-in mounting clip is able to keep the lamp in the same curved surface of handrail,
 it looks more beautiful and elegant
 Suit for handrail with Ø42.4/Ø48.3/Ø60.3mm
 Color temperature from 2700K- 6500K
 Can be driven by 12V and 24V LED power supply
 IP 67

Suit for class 2 power unit, we suggest maximum connected power not more than 100W

M26 Clip in Handrail Light

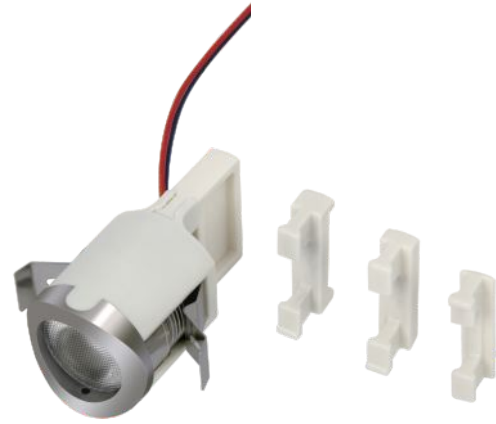
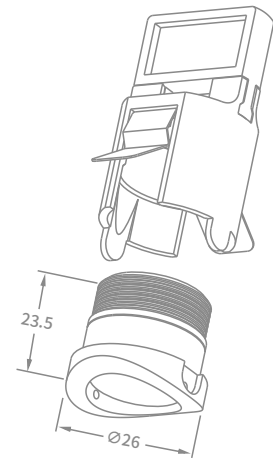

Model	Beam Angle	Dimension	Input Voltage	Power
M26 Clip in	60°	φ26 X H23.5mm	3V DC	1.5W
M26 Clip in	ASymmetric-80°	φ26 X H23.5mm	3V DC	1.5W
M26 Clip in	60°	φ26 X H23.5mm	24V DC	1.5W
M26 Clip in	ASymmetric-80°	φ26 X H23.5mm	24V DC	1.5W

Suitable for the following handrail tubes

Outer Diameter	Tube Thickness	Drill Size
Ø48.3mm	3.68mm	Ø26mm
Ø42.2mm	1.80mm	Ø26mm
Ø42.2mm	3.56mm	Ø26mm
Ø38.0mm	1.80mm	Ø26mm
Ø38.0mm	3.0mm	Ø26mm



M26 LED handrail lighting
Stainless steel housing,
the built-in mounting clip is able to
keep the lamp in the same
curved surface of handrail,
it looks more beautiful and elegant
Suit for handrail with Ø38.0/Ø42.2/Ø48.3mm
Color temperature from 2700K-6500K
Can be driven by 12V and 24V LED power supply
IP 67

Suit for class 2 power unit, we suggest maximum
connected power not more than 100W

M25 LED Handrail Light

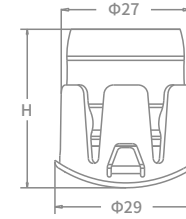

Model	Beam Angle	Dimension	Input Voltage	Power	Net Weight
M25	60°	φ29 X H30.5mm	3V DC	1.5W	42g
M25	60°	φ29 X H30.5mm	24V DC	1.5W	42g
M25 RGB-DMX	60°	φ29 X H30.5mm	24V DC	2W	42g
M25	Asymmetric-80°	φ29 X H26.7mm	3V DC	1.5W	38g
M25	Asymmetric-80°	φ29 X H26.7mm	24V DC	1.5W	38g
M25 RGB-DMX	Asymmetric-80°	φ29 X H26.7mm	24V DC	2W	38g



M25 LED handrail lighting
Stainless steel housing, the special mounting clip is able to
make the fixing become more easy and simple
Suit for handrail with Ø48-Ø60.3mm and wall thickness in 1-1.5mm.
Color temperature from 2700K-6500K, or DMX RGB
Can be driven by 12V and 24V LED power supply
IP 67

Suit for class 2 power unit, we suggest maximum
connected power not more than 100W

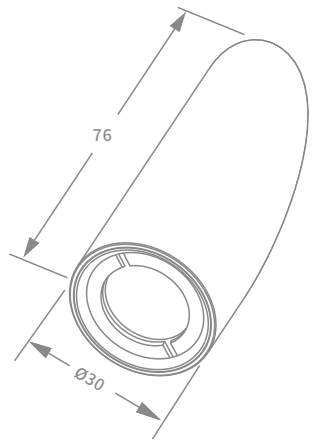

Model	Beam Angle	Dimension	Input Voltage	Power
M3076-50	50°	φ30 X H76mm	3V DC	2W

M3076-50 LED Handrail Light
 LED Handrail Lighting System
 Housing: Stainless steel
 Suitable for handrail tube Ø50.8mm
 wall thickness 1.5~5mm
 IP Rating: IP67
 Power Supply: Constant current, 700mA

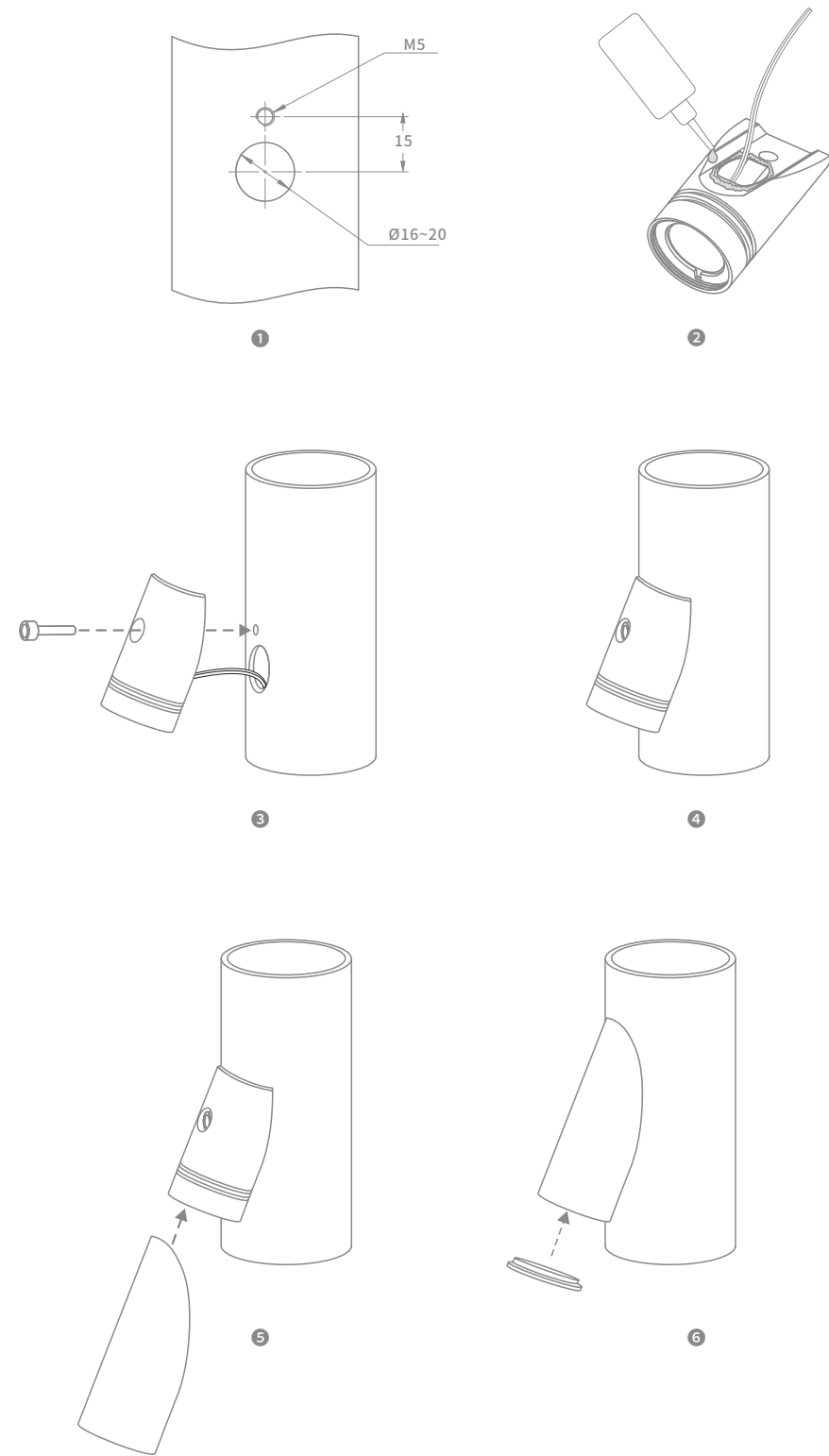

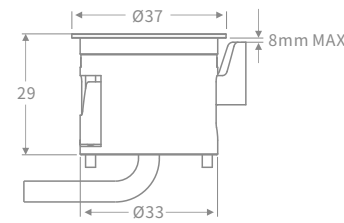
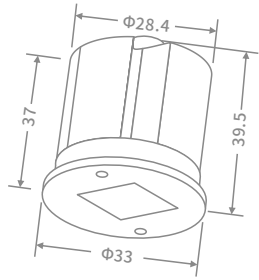

NOT FOR AUSTRALIA AND NEW ZEALAND MARKET!

Model	Beam Angle	Dimension	Input Voltage	Power	Net Weight
S29	80°	φ33 X H39.5mm	24V DC	1.5W	71g
S29	Asymmetric-60°	φ33 X H39.5mm	24V DC	1.5W	71g

Model	Beam Angle	Dimension	Input Voltage	Power	Net Weight
S33	Asymmetric-90°	φ37 X H29mm	24V DC	1.5W	132g

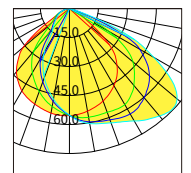
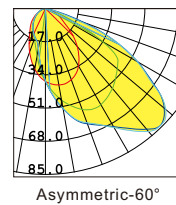
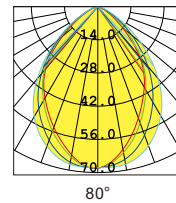

S29 LED handrail lighting , aluminum housing,
 suit for square handrail with ≥45mm and wall thickness 0.8-3mm.
 Can be driven by 12V and 24V LED power supply
 Color temperature from 2700K-6500K
 IP 67

suit for class 2 power unit, we suggest maximum
 connected power not more than 100W

S33 LED handrail lighting ,
 Stainless steel housing,
 suit for square handrail with ≥45 X and wall thickness 1-3mm
 can be driven by 12V and 24V LED power supply
 Color temperature from 2700K-6500K
 IP 67

suit for class 2 power unit,
 we suggest maximum connected
 power not more than 100W

S18R LED Linear Handrail Light

S18S LED Linear Handrail Light-NEW

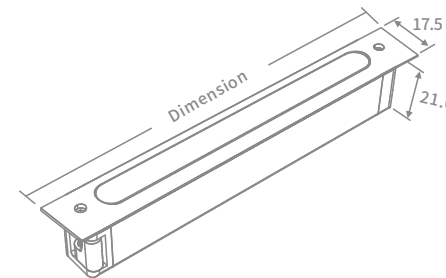
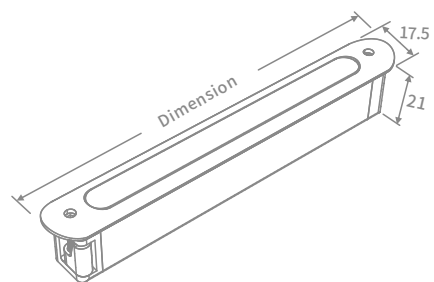

Model	Beam Angle	Dimension	Input Voltage	Power	Net Weight
S18R085	110°	W17.5 * H21 * L85mm	24V DC	0.5W	45g
S18R185	110°	W17.5 * H21 * L185mm	24V DC	1.5W	
S18R285	110°	W17.5 * H21 * L285mm	24V DC	2.5W	
S18R385	110°	W17.5 * H21 * L385mm	24V DC	3.5W	

Model	Beam Angle	Dimension	Input Voltage	Power	Net Weight
S18S080	110°	W17.5 * H21 * L80mm	24V DC	0.5W	45g
S18S180	110°	W17.5 * H21 * L180mm	24V DC	1.5W	
S18S280	110°	W17.5 * H21 * L280mm	24V DC	2.5W	
S18S380	110°	W17.5 * H21 * L380mm	24V DC	3.5W	

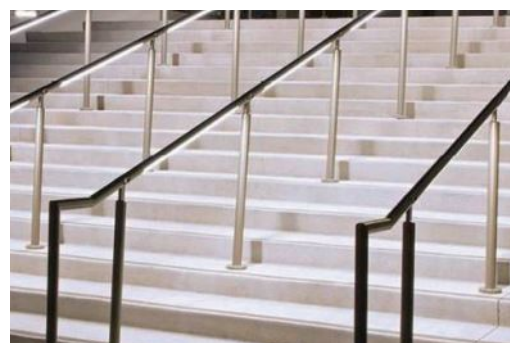

S18R LED linear handrail light,
Aluminum housing,
Suit for handrail size > Ø38mm and wall thickness 0.8-3mm
Color temperature 1800K-6500K
IP65 waterproof.

S18S LED linear handrail light,
Aluminum housing,
Suit for square handrail size > Ø30mm and wall thickness 0.8-3mm
Color temperature 1800K-6500K
IP65 waterproof.

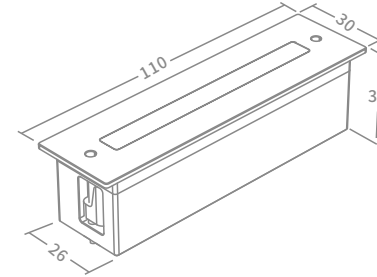
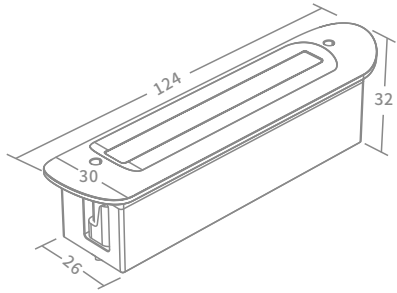

Model	Dimension	CCT	Input Voltage	Power	Net Weight
S30R	W30*H32*L124mm	2700K-6500K DMX tunable white	24V DC	4W	154g
S30R	W30*H32*L124mm	2700K-6500K DMX single colour	24V DC	4W	154g
S30R	W30*H32*L124mm	2700K-6500K Single colour	24V DC	4W	154g

Model	Dimension	CCT	Input Voltage	Power	Net Weight
S30S	W30*H30*L110mm	2700K-6500K DMX tunable white	24V DC	4W	154g
S30S	W30*H30*L110mm	2700K-6500K DMX single colour	24V DC	4W	154g
S30S	W30*H30*L110mm	2700K-6500K Single colour	24V DC	4W	154g

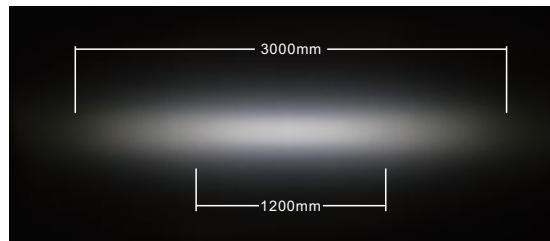

Lighting effect from 1meter distance to the ground

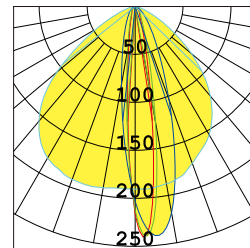

10°X 100°

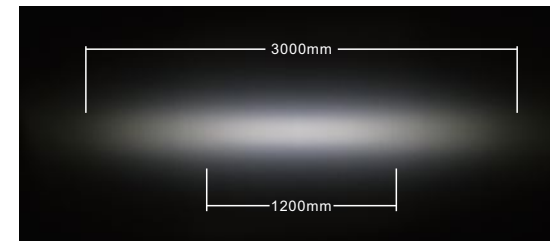

Lighting effect from 1meter distance to the ground

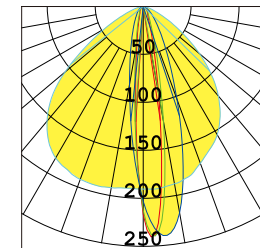

10°X 100°

S30R 10° beam angle LED handrail lighting
 Aluminum housing,
 Suit for round handrail size from Ø38-52mm and wall thickness 0.8-3mm
 IP 65

S30S 10° beam angle LED handrail lighting
 Aluminum housing,
 Suit for round handrail size >Ø45mm which wall thickness 0.8-3mm
 IP 65

UGD2622 Underground Lamp

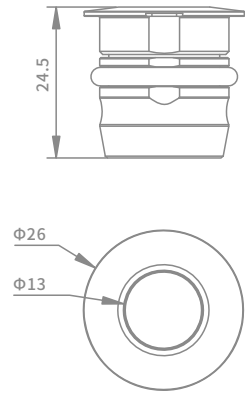

Model	Dimension	Input Voltage	Power	Beam Angle	Net Weight
UGD2622	φ26 X H24.5mm	24V DC	1W	70°	50g

UGD3530 Underground Lamp

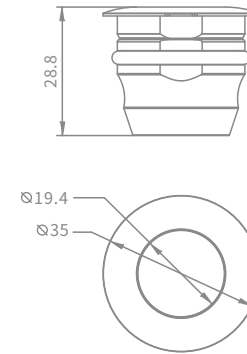

Model	Dimension	Input Voltage	Power	Beam Angle	Net Weight
UGD3530	φ35 X H28.8mm	24V DC	1W	80°	85g
UGD3530 RGB-DMX	φ35 X H28.8mm	24V DC	2W	80°	85g

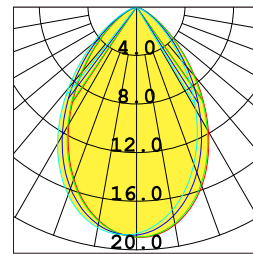

70°

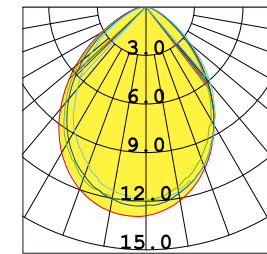

80°

Mini LED underground lamp
 Stainless steel material
 Easy installation and easy repairing
 Single color or RGB
 Different beam angle are available on request
 Working Temperature:-40°C~+45
 IP68

Mini LED underground lamp
 Stainless steel material
 Easy installation and easy repairing
 Single color or RGB
 Different beam angle are available on request
 Working Temperature:-40°C~+45
 IP68