

WE CONTINUE BEYOND THE NEXT MOMENT AT A HIGHER POINT

我们不断超越，下一刻，在更高点....

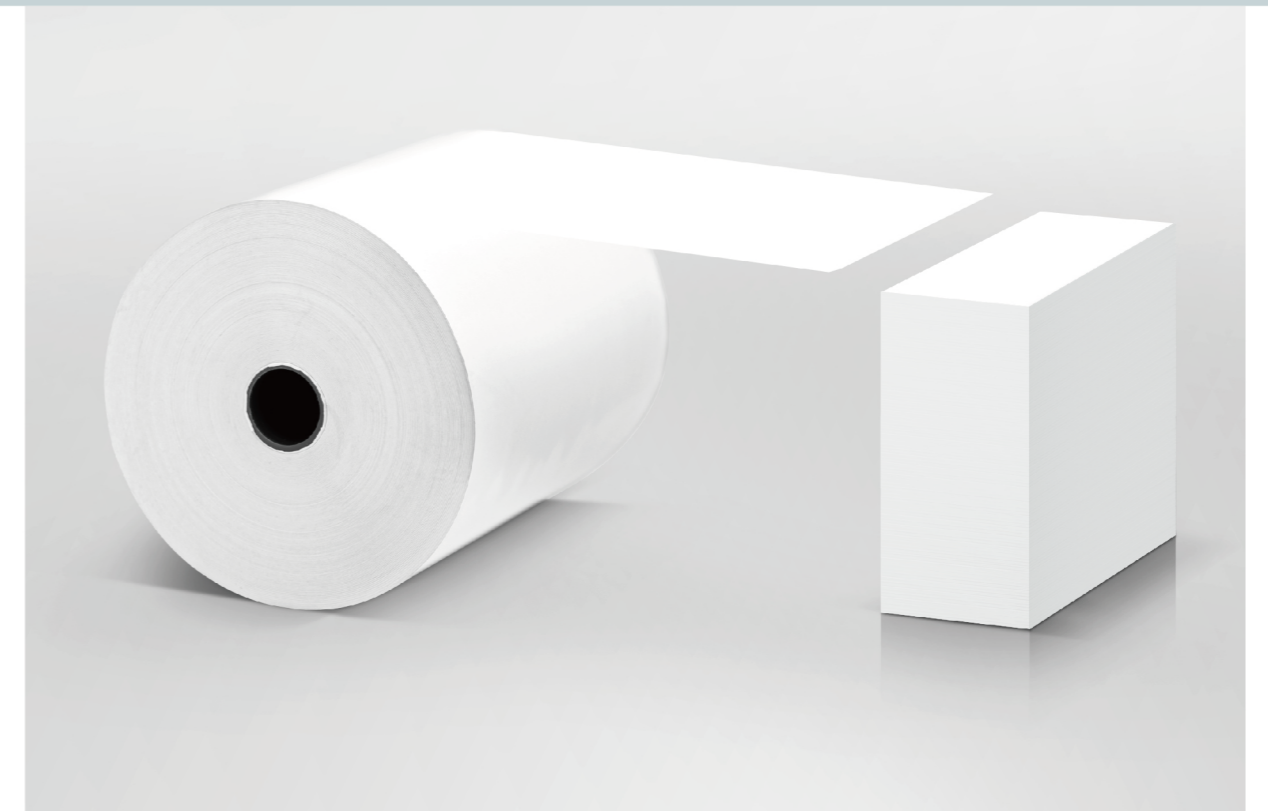

SCAN →



HOUSEING 豪盛

ZHEJIANG HAOSHENG PRINTING
MACHINERY CO.,LTD
浙江豪盛印刷机械有限公司

浙江省瑞安市锦湖街道芦浦工业区
Lupu Industrial Area, Jinhua street,
Ruian City, Zhejiang Province
Tel. 086-0577-6587 3666 6580 0387
Fax. 086-0577-6580 2228 **After-sale hotline.** 0577-6509 9666
E-mail. ruifeng@china-ruifeng.com

kingstar reserve the right to change the right to change technical characteristics without previous advice
本公司有权保留对机器技术参数的修改，不另通知。



HOUSEING 豪盛

A PROFESSIONAL MANUFACTURER OF SHEET CUTTER MACHINE

做最优秀的卷筒切纸机

Founded in May 2002, Zhejiang Haosheng Printing Machinery Co., Ltd. was formerly named Ruian Hao Sheng Printing Machinery Co., Ltd., has been more than 10 years of history. Our company was licensed as a "national high-tech enterprises in September 2011.

Zhejiang Haosheng printing machinery Co., Ltd. is a professional manufacturer specialized in production of cutting machine, horizontal cutting machine and other products. The company has permit of import and export, meanwhile company has passed ISO9001:2000 quality management system certification, our equipment has passed the European CE certification; the products are widely exported to Europe, America, Middle East and Southeast Asia, and other countries. The company has been committed to development of new products, and provides quality equipment for domestic and overseas market. The company is well-known of its excellent equipment quality, strong technical background, production management, sales and service organizations. The set of the latest scientific and innovative technology is our key competence in market.

The Company have always adhered to business philosophy of "quality and credibility, efficiency, effectiveness and development". We are continuing beyond the next moment at a higher point.

浙江豪盛印刷机械有限公司前身是瑞安豪盛印刷机械有限公司，创办于2002年5月，至今已有十多年的历史。2011年9月，被评为“国家高新技术企业”。

本公司是一家专业生产卷筒纸切纸机、电脑横切机、裱卡机等系列产品的专业企业。公司拥有自营进出口权，企业已通过ISO9001:2000质量管理体系认证，设备已通过欧洲CE认证，产品远销欧美、中东和东南亚等地区，现在全球已有众多国家用户启用我公司的设备。多年来，我公司一直致力于新产品的开发与研制，努力为国内外客户提供优质的设备。公司具有精良的生产设备，雄厚的技术力量，并拥有强大的科技开发、生产管理、销售服务机构、集最新科学与创新技术立足市场、参与市场竞争，使企业在市场享有较高的知名度。

企业始终本着“以质量求信誉、以信誉求生存、以管理求效益、以效益求发展”的企业理念，做好设备，做强企业。



HSC

1500SS 1700SS 1900SS

High-precision Smart Double
Rotary Sheet Cutter Machine
智能高精度双螺旋分切机

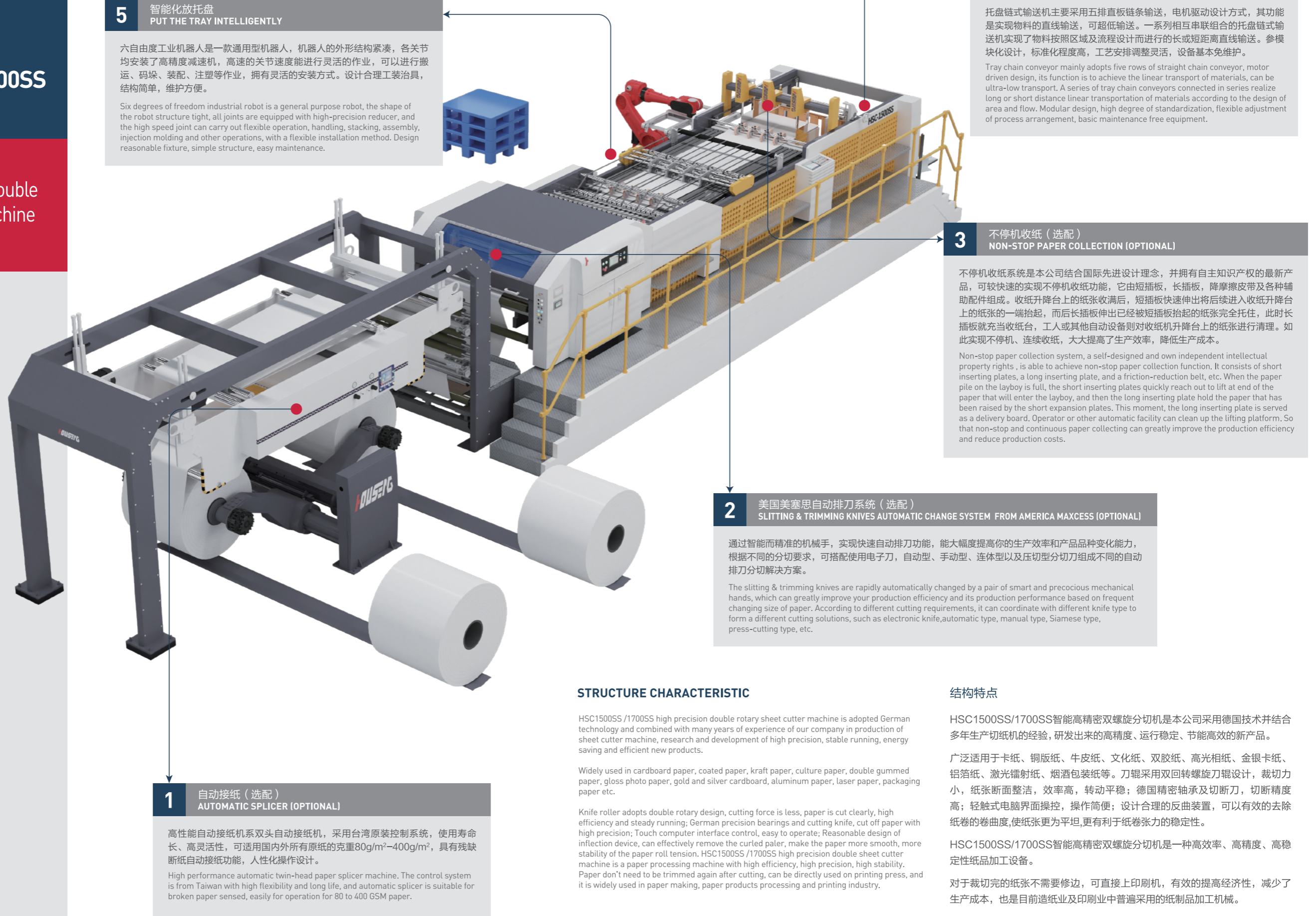
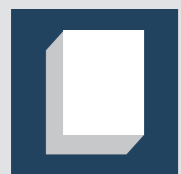
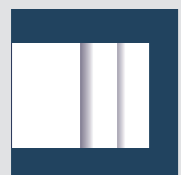
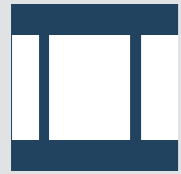
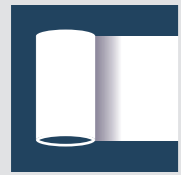

5 智能化放托盘 PUT THE TRAY INTELLIGENTLY

六自由度工业机器人是一款通用型机器人，机器人的外形结构紧凑，各关节均安装了高精度减速机，高速的关节速度能进行灵活的作业，可以进行搬运、码垛、装配、注塑等作业，拥有灵活的安装方式。设计合理工装夹具，结构简单，维护方便。

Six degrees of freedom industrial robot is a general purpose robot, the shape of the robot structure tight, all joints are equipped with high-precision reducer, and the high speed joint can carry out flexible operation, handling, stacking, assembly, injection molding and other operations, with a flexible installation method. Design reasonable fixture, simple structure, easy maintenance.



4 自动物流系统 AUTOMATIC DELIEVE SYSTEM

托盘链式输送机主要采用五排直板链条输送，电机驱动设计方式，其功能是实现物料的直线输送，可超低输送。一系列相互串联组合的托盘链式输送机实现了物料按照区域及流程设计而进行的长或短距离直线输送。参模块化设计，标准化程度高，工艺安排调整灵活，设备基本免维护。

Tray chain conveyor mainly adopts five rows of straight chain conveyor, motor driven design, its function is to achieve the linear transport of materials, can be ultra-low transport. A series of tray chain conveyors connected in series realize long or short distance linear transportation of materials according to the design of area and flow. Modular design, high degree of standardization, flexible adjustment of process arrangement, basic maintenance free equipment.

3 不停机收纸（选配） NON-STOP PAPER COLLECTION (OPTIONAL)

不停机收纸系统是本公司结合国际先进设计理念，并拥有自主知识产权的最新产品，可较快速的实现不停机收纸功能，它由短插板，长插板，降摩擦皮带及各种辅助配件组成。收纸升降台上的纸张收满后，短插板快速伸出将后续进入收纸升降台上的纸张的一端抬起，而后长插板伸出已经被短插板抬起的纸张完全托住，此时长插板就充当收纸台，工人或其他自动设备则对收纸机升降台上的纸张进行清理。如此实现不停机、连续收纸，大大提高了生产效率，降低生产成本。

Non-stop paper collection system, a self-designed and own independent intellectual property rights, is able to achieve non-stop paper collection function. It consists of short inserting plates, a long inserting plate, and a friction-reduction belt, etc. When the paper pile on the layboy is full, the short inserting plates quickly reach out to lift at end of the paper that will enter the layboy, and then the long inserting plate hold the paper that has been raised by the short expansion plates. This moment, the long inserting plate is served as a delivery board. Operator or other automatic facility can clean up the lifting platform. So that non-stop and continuous paper collecting can greatly improve the production efficiency and reduce production costs.

2 美国美塞思自动排刀系统（选配） SLITTING & TRIMMING KNIVES AUTOMATIC CHANGE SYSTEM FROM AMERICA MAXCESS (OPTIONAL)

通过智能而精准的机械手，实现快速自动排刀功能，能大幅度提高你的生产效率和产品品种变化能力，根据不同的分切要求，可搭配使用电子刀，自动型、手动型、连体型以及压切型分切刀组成不同的自动排刀分切解决方案。

The slitting & trimming knives are rapidly automatically changed by a pair of smart and precocious mechanical hands, which can greatly improve your production efficiency and its production performance based on frequent changing size of paper. According to different cutting requirements, it can coordinate with different knife type to form a different cutting solutions, such as electronic knife, automatic type, manual type, Siamese type, press-cutting type, etc.

STRUCTURE CHARACTERISTIC

HSC1500SS/1700SS high precision double rotary sheet cutter machine is adopted German technology and combined with many years of experience of our company in production of sheet cutter machine, research and development of high precision, stable running, energy saving and efficient new products.

Widely used in cardboard paper, coated paper, kraft paper, culture paper, double gummed paper, gloss photo paper, gold and silver cardboard, aluminum paper, laser paper, packaging paper etc.

Knife roller adopts double rotary design, cutting force is less, paper is cut clearly, high efficiency and steady running; German precision bearings and cutting knife, cut off paper with high precision; Touch computer interface control, easy to operate; Reasonable design of inflection device, can effectively remove the curled paler, make the paper more smooth, more stability of the paper roll tension. HSC1500SS/1700SS high precision double sheet cutter machine is a paper processing machine with high efficiency, high precision, high stability. Paper don't need to be trimmed again after cutting, can be directly used on printing press, and it is widely used in paper making, paper products processing and printing industry.

结构特点

HSC1500SS/1700SS智能高精度双螺旋分切机是本公司采用德国技术并结合多年生产切纸机的经验，研发出来的高精度、运行稳定、节能高效的新产品。

广泛适用于卡纸、铜版纸、牛皮纸、文化纸、双胶纸、高光相纸、金银卡纸、铝箔纸、激光镭射纸、烟酒包装纸等。刀辊采用双回转螺旋刀辊设计，裁切力小，纸张断面整洁，效率高，转动平稳；德国精密轴承及切断刀，切断精度高；轻触式电脑界面操控，操作简便；设计合理的反曲装置，可以有效的去除纸卷的卷曲度，使纸张更为平坦，更有利于纸卷张力的稳定性。

HSC1500SS/1700SS智能高精度双螺旋分切机是一种高效率、高精度、高稳定性纸品加工设备。

对于裁切完的纸张不需要修边，可直接上印刷机，有效的提高经济性，减少了生产成本，也是目前造纸业及印刷业中普遍采用的纸制品加工机械。

1 自动接纸（选配） AUTOMATIC SPLICER (OPTIONAL)

高性能自动接纸机系双头自动接纸机，采用台湾原装控制系统，使用寿命长、高灵活性，可适用国内外所有原纸的克重80g/m²-400g/m²，具有残缺断纸自动接纸功能，人性化操作设计。

High performance automatic twin-head paper splicer machine. The control system is from Taiwan with high flexibility and long life, and automatic splicer is suitable for broken paper sensed, easily for operation for 80 to 400 GSM paper.

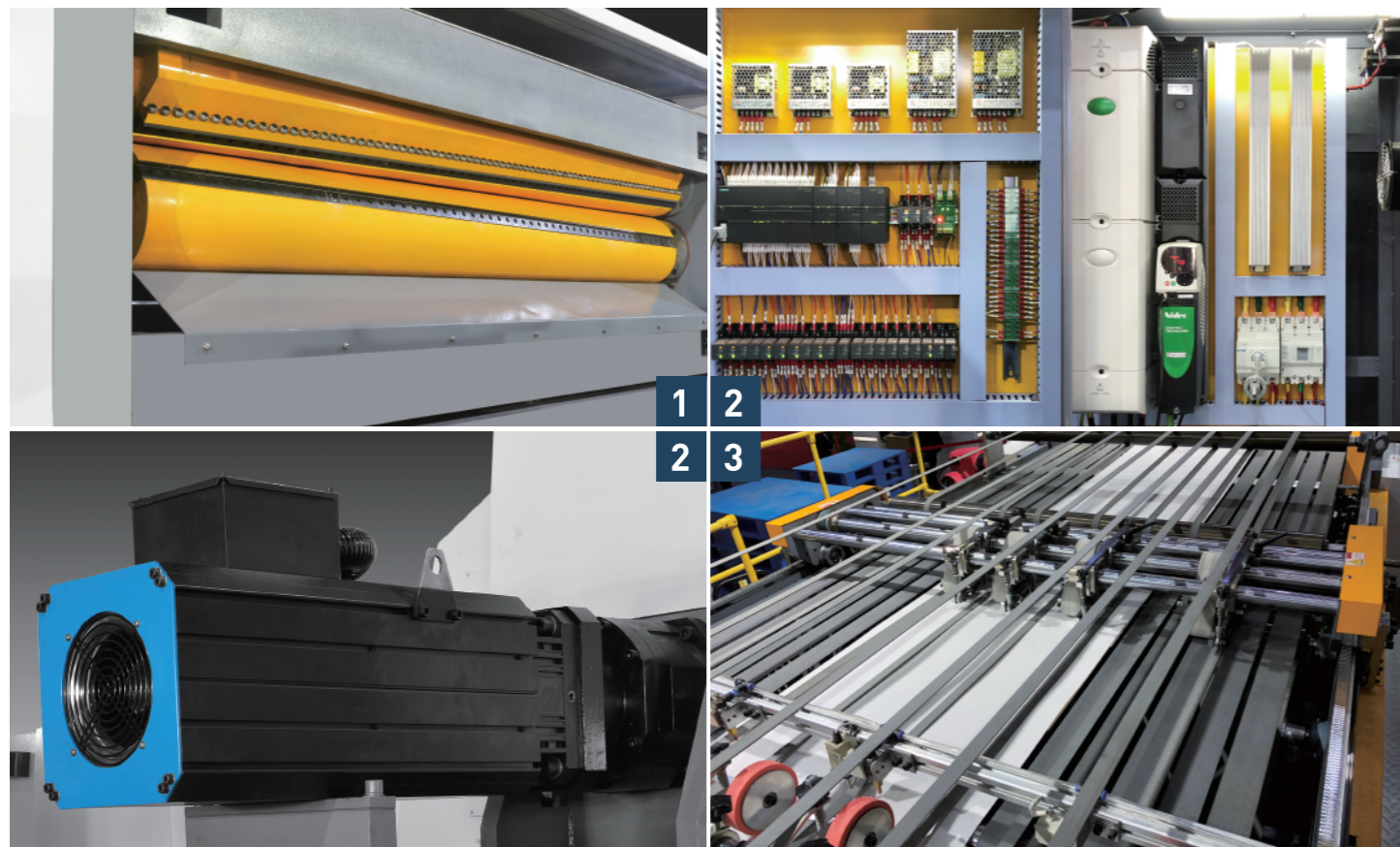

1 DOUBLE ROTARY SHEETER GROUP 上下刀双回旋螺旋刀组

2 ELECTRIC CONTROL PART 电控部分

Precision rotary sheeter groove is processed by imported advanced processing center with high accuracy and stability, cutting paper without burrs; High quality gear box, using no clearance design gear, meshing noise is low, life is twice longer than the traditional gear box; Good cast ductile iron wall and supporting parts, After aging treatment, again by imports of large vertical machining center, precision high level requirements, processing error is smaller, the operation of the machine more stable and reliable.

进口高级加工中心精密加工螺旋刀槽，精度高，稳定性佳，裁切纸张无毛边；优质齿轮箱，使用无间隙设计齿轮，啮合噪音低，比传统齿轮箱寿命长一倍；上好的球墨铸铁铸造而成的车壁和支撑件，经时效处理后，再由进口的大型立体加工中心加工而成，精度等级要求高，加工的误差更小，整机的运行更稳定，可靠。

German imported Siemens PLC and The United States Emerson servo drive control system make the operation simpler and automatic. Cutting length, product number and the total number of finished products, etc. can be directly input and displayed on touch screen timely. The American CT servo drive rotary knife shaft, and cooperate with energy storage cabinet, effectively reduce power consumption, improve efficiency, reduce production cost

全部采用德国进口的西门子 PLC 及美国艾默生的驱动器控制系统，使操作更为简便、自动化，切断长度、数量及成品总数等，可直接在触摸屏里输入。实际切断长度及裁切数量可及时显示。高效节能的大功率美国 CT 伺服驱动螺旋刀轴，并配合储能柜，有效减少电能的损耗，提高了经济性，减少了生产成本。

3 TRANSPORTATION PART 输送部分

Patent device - A precision structure can adjust the synchronous deceleration wheel, easy to operate, it's effective to protect surface of paper, so there will be no scratching on surface, and also will not have the facula whenever speed is high or low..

专利机构 - 可调节同步减速轮，操作方便，结构精密，减速轮采用同步动力并新增缓冲减速带，使纸张形成高低差速叠纸过程中不会产生猛烈冲击，针对易划伤纸张有很好的效果，不会有痕迹，也不会留下光斑。



MAIN TECHNICAL PARAMETER

主要技术参数

Model	型号	HSC 1500SS/1700SS/1900SS	切纸长度(mm) Cutting Length	每分钟米速 (m/min) Speed	每分钟刀速 (cuts/min) Speed
Model of cutting paper	切纸形式	双回旋刀 Double rotary sheeter	≥1600	210	< 131
Reference weight of cutting paper	纸张适用范围	150-1000GSM	≥1400 < 1600	260	≥162 < 185
Max.roll diameter	最大卷筒纸直径	1800mm(71")Max	≥1200 < 1400	280	≥200 < 233
Max. paper cutting width	最大纸幅	1500mm/1700mm	≥1000 < 1200	300	≥250 < 300
Total power	总功率	90kw	≥800 < 1000	300	≥300 < 375
Cutting length range	切断长度	400-1650mm	≥700 < 800	300	≥375 < 400
Cutting accuracy	切断精度	+/-0.15mm	≥650 < 700	230	≥328 < 353
The request for air compressor	气压源需求	0.8MPa	≥600 < 650	180	≥246 < 300
Weight	总重量	28000kgs/31000kgs	≥550 < 600	160	≥266 < 290
Overall Dimension	外形尺寸	L18241xW5900xH2540mm	≥500 < 550	120	≥218 < 240
			≥450 < 500	90	≥180 < 200
			≥400 < 450	70	≥155 < 175

*Our company reserves the right to change technical characteristics without further notice.

*公司有权保留对机器技术参数的修改，恕不另行通知。

HSC 1500SS/1700SS/1900SS STRUCTURAL ANALYSIS OF FIG 构造解析图

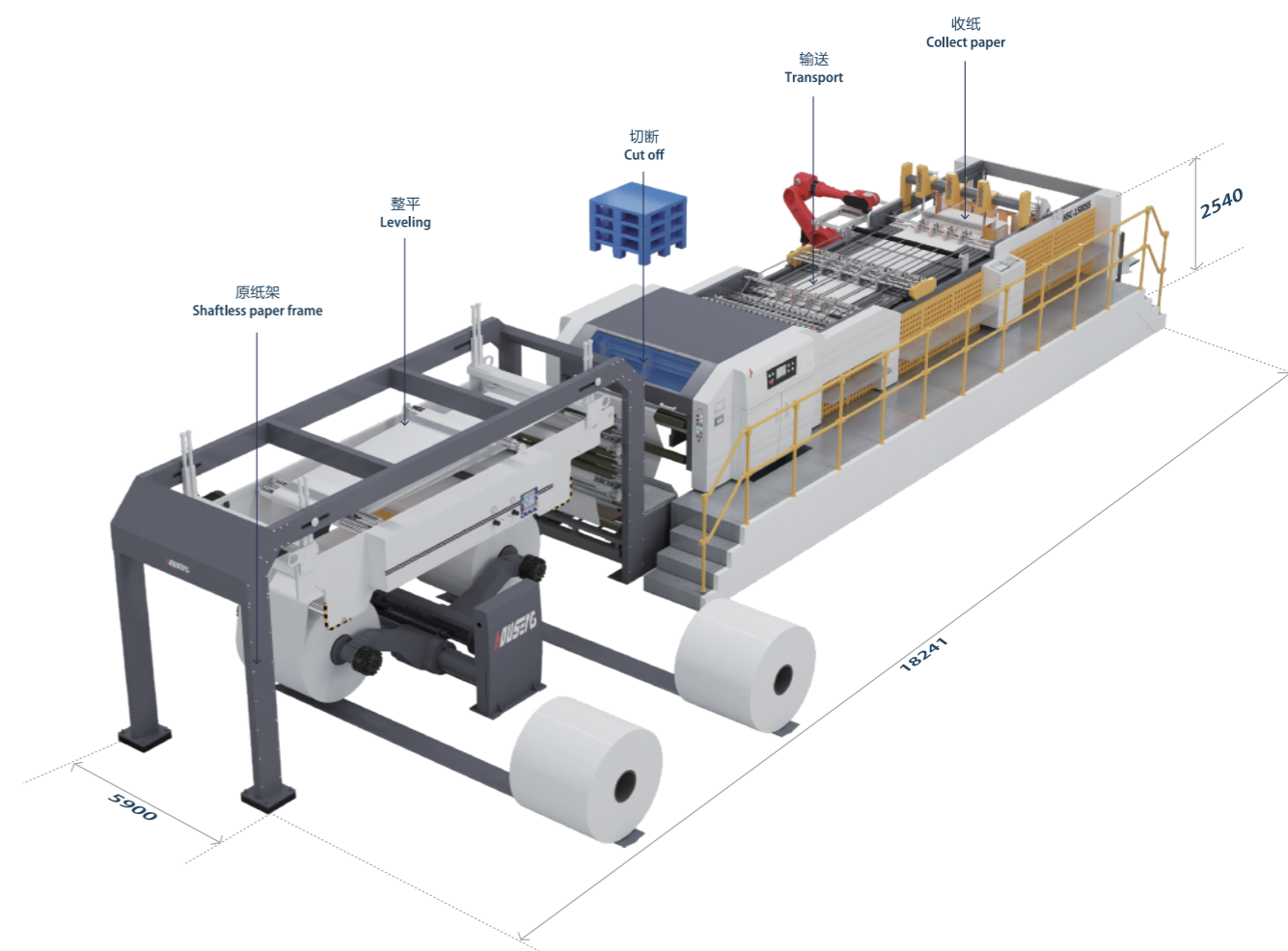

HSC

1500S 1700S 1900S

High Precision Double
Rotary Sheet Cutter machine

高精度双螺旋分切机

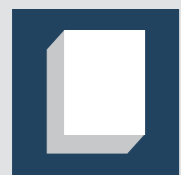
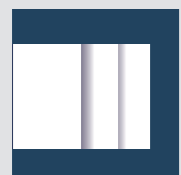
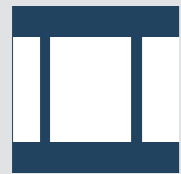
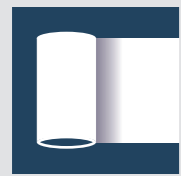
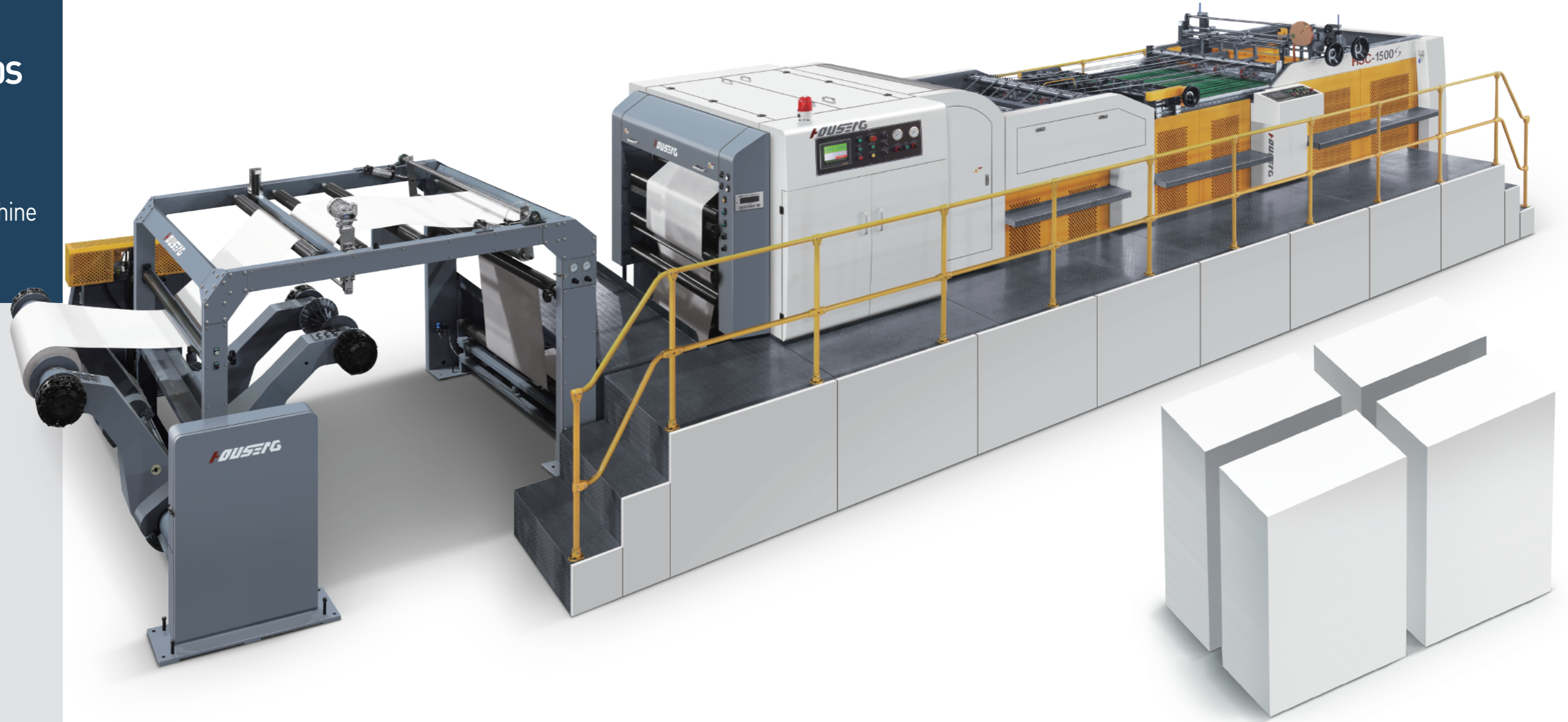

STRUCTURE CHARACTERISTIC

HSC1500S /1700S high precision double rotary sheet cutter machine is adopted German technology and combined with many years of experience of our company in production of sheet cutter machine, research and development of high precision, stable running, energy saving and efficient new products.

Widely used in cardboard paper, coated paper, kraft paper, culture paper, double gummed paper, gloss photo paper, gold and silver cardboard, aluminum paper, laser paper, packaging paper etc.

Knife roller adopts double rotary design, cutting force is less, paper is cut clearly, high efficiency and steady running; German precision bearings and cutting knife, cut off paper with high precision; Touch computer interface control, easy to operate; Reasonable design of inflection device, can effectively remove the curled paper, make the paper more smooth, more stability of the paper roll tension. HSC1500SS /1700SS high precision double sheet cutter machine is a paper processing machine with high efficiency, high precision, high stability. Paper don't need to be trimmed again after cutting, can be directly used on printing press, and it is widely used in paper making, paper products processing and printing industry.

结构特点

HSC1500S/1700S/1900S高精度双螺旋分切机是本公司采用德国技术并结合多年生产切纸机的经验,研发出来的高精度、运行稳定、节能高效的新产品。

广泛适用于卡纸、铜版纸、牛皮纸、文化纸、双胶纸、高光相纸、金银卡纸、铝箔纸、激光镭射纸、烟酒包装纸等。刀辊采用双回转螺旋刀辊设计,裁切力小,纸张断面整洁,效率高,转动平稳;德国精密轴承及切断刀,切断精度高;轻触式电脑界面操控,操作简便;设计合理的反曲装置,可以有效的去除纸卷的卷曲度,使纸张更为平坦,更有利于纸卷张力的稳定性。

HSC1500S/1700S/1900S高精度双螺旋分切机是一种高效率、高精度、高稳定性纸品加工设备。

对于裁切完的纸张不需要修边,可直接上印刷机,有效的提高经济性,减少了生产成本,也是目前造纸业及印刷业中普遍采用的纸制品加工机械。



1 DOUBLE ROTARY SHEETER GROUP 上下刀 双回旋螺旋刀组 **2 ELECTRIC CONTROL PART** 电控部分

Precision rotary sheeter groove is processed by imported advanced processing center with high accuracy and stability, cutting paper without burrs; High quality gear box, using no clearance design gear, meshing noise is low, life is twice longer than the traditional gear box; Good cast ductile iron wall and supporting parts, After aging treatment, again by imports of large vertical machining center, precision high level requirements, processing error is smaller, the operation of the machine more stable and reliable.

进口高级加工中心精密加工螺旋刀槽，精度高，稳定性佳，裁切纸张无毛边；优质齿轮箱，使用无间隙设计齿轮，啮合噪音低，比传统齿轮箱寿命长一倍；上好的球墨铸铁铸造而成的车壁和支撑件，经时效处理后，再由进口的大型立体加工中心加工而成，精度等级要求高，加工的误差更小，整机的运行更稳定，可靠。

3 CUTTING UNIT 纵切部分 **4 TRANSPORTATION PART** 输送部分

Top shear air knife innovative design enables pneumatic movement of precise adjustment for upper and lower knife. The pneumatic knife is suitable for wide range of application in light paper, plastic film, optic film and copper or aluminum foil different materials. Rigid knife holder has excellent rigidity to perform high speed slitting up to 300m/min with excellent slitting quality.

剪切式气动上分条刀组创新设计具有二段式自动气压下刀及靠刀动作，精确调整上下刀片重叠深度，可因不同入料方向来调整刀片角度及免工具快速固定刀组等特点。剪切式分切方式具有分切时粉末少，切面光滑及高速分切等特点。高刚性刀架更适用于 300m/min 高速分条环境，提高生产效率并确保材料品质稳定性。

German imported Siemens PLC and The United States Emerson servo drive control system make the operation simpler and automatic. Cutting length, product number and the total number of finished products, etc. can be directly input and displayed on touch screen timely. The American CT servo drive rotary knife shaft, and cooperate with energy storage cabinet, effectively reduce power consumption, improve efficiency, reduce production cost

全部采用德国进口的西门子 PLC 及美国艾默生的驱动器控制系统，使操作更为简便、自动化，切断长度、数量及成品总数等，可直接在触摸屏里输入。实际切断长度及裁切数量可及时显示。高效节能的大功率美国 CT 伺服驱动螺旋刀轴，并配合储能柜，有效减少电能的损耗，提高了经济性，减少了生产成本。

Patent device – A precision structure can adjust the synchronous deceleration wheel, easy to operate, it's effective to protect surface of paper, so there will be no scratching on surface, and also will not have the facula whenever speed is high or low..

专利机构 – 可调节同步减速轮，操作方便，结构精密，减速轮采用同步动力并新增缓冲减速带，使纸张形成高低差速叠纸过程中不会产生猛烈冲击，针对易划伤纸张有很好的效果，不会有痕迹，也不会留下光斑。

MAIN TECHNICAL PARAMETER
主要技术参数

Model	型号	HSC 1500S/1700S	切纸长度(mm) Cutting Length	每分钟米速 (m/min) Speed	每分钟刀速 (cuts/min) Speed
Model of cutting paper	切纸形式	双回旋刀 Double rotary sheeter	≥1600	210	< 131
Reference weight of cutting paper	纸张适用范围	150-1000GSM	≥1400 < 1600	260	≥162 < 185
Max.roll diameter	最大卷筒纸直径	1800mm[71 "]Max	≥1200 < 1400	280	≥200 < 233
Max. paper cutting width	最大纸幅	1500mm/1700mm	≥1000 < 1200	300	≥250 < 300
Total power	总功率	90kw	≥800 < 1000	300	≥300 < 375
Cutting length range	切断长度	400-1450mm/400-1650mm	≥700 < 800	300	≥375 < 400
Cutting accuracy	切断精度	+/-0.15mm	≥650 < 700	230	≥328 < 353
The request for air compressor	气压源需求	0.8MPa	≥600 < 650	180	≥246 < 300
Weight	总重量	21000kgs/23000kgs	≥550 < 600	160	≥266 < 290
Overall Dimension	外形尺寸	L16175xW5900xH2533mm	≥500 < 550	120	≥218 < 240
			≥450 < 500	90	≥180 < 200
			≥400 < 450	70	≥155 < 175

*Our company reserves the right to change technical characteristics without further notice.
*公司有权保留对机器技术参数的修改，恕不另行通知。

HSC 1500S/1700S STRUCTURAL ANALYSIS OF FIG 构造解析图

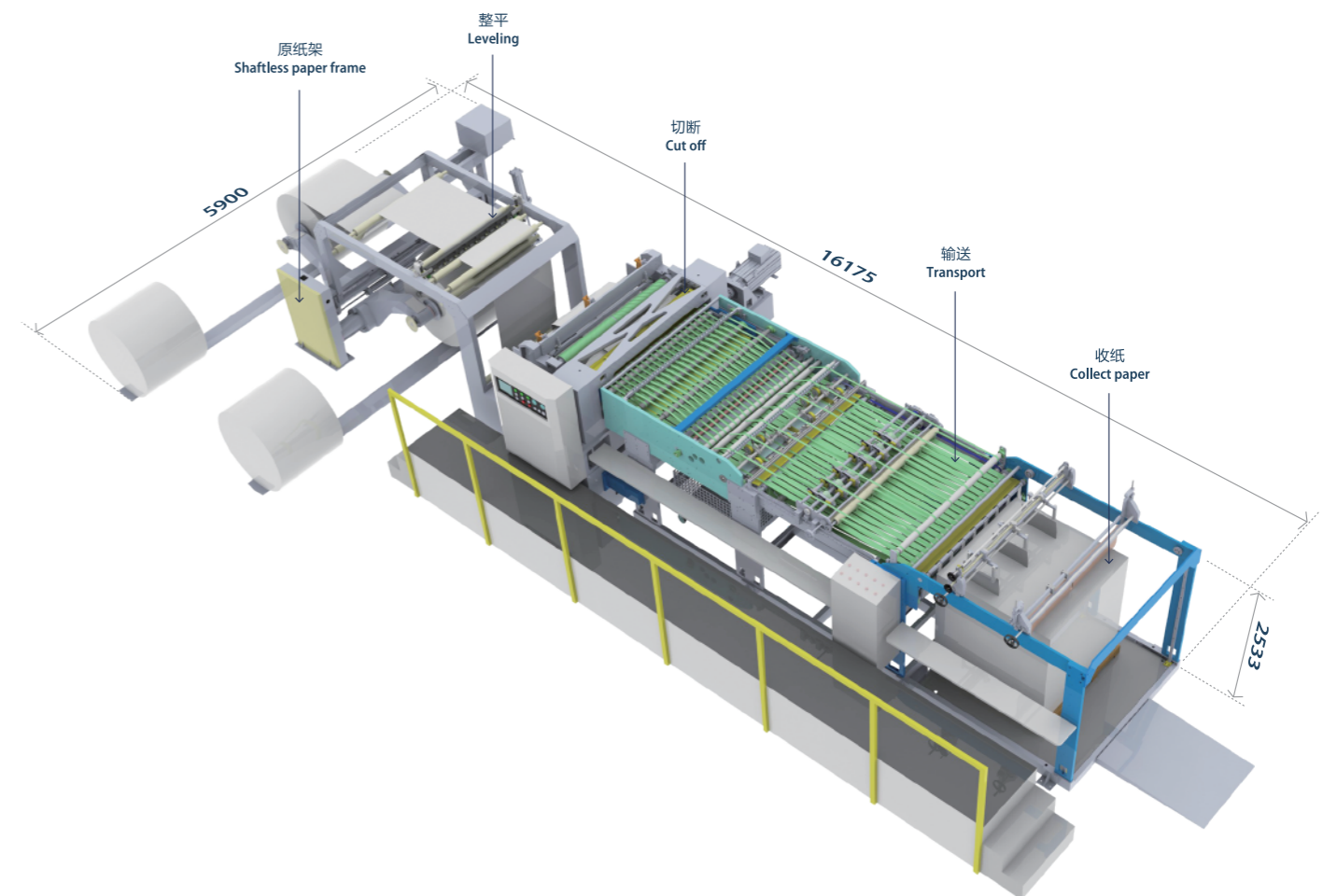

HSC

1400 1700 1900

Servo Driven High Precision Sheet Cutter

伺服传动电脑高精度
铜版纸分切机

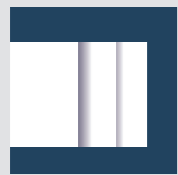
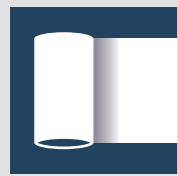
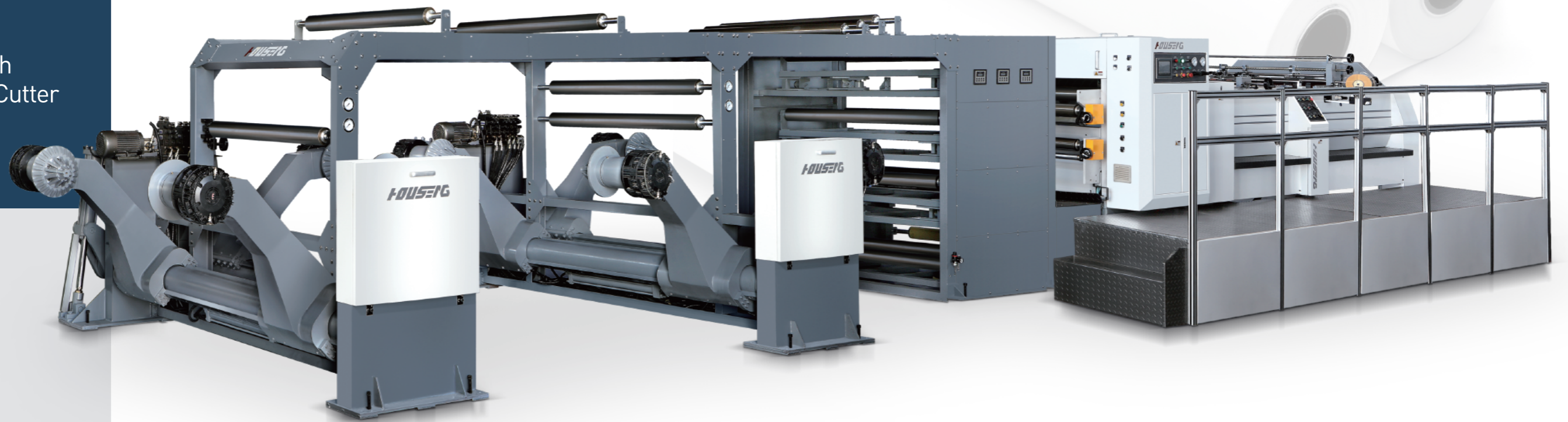

STRUCTURE CHARACTERISTIC

- HSC web cutting machine uses the advanced technology of Taiwan and Britain,
- The machine is driven by AC servo motor.
- The speed of paper cutting is fast and stable.
- Germany precise bearing and cutting knife assure the high cutting precision.
- Touch screen computer interface control, simple operation, reasonable structure,
- Anti-noise stands, to ensure smooth paper.

This machine is widely used in paper making, paper products processing and printing industry, and will improve efficiency and increase benefit for your company.

THE CONTENT OF STANDARD CONFIGURATION

1. High-precision single knife cutting machine
2. Prismatic adjustment system for paper
3. Anti-static equipment
4. Middle slitting and waste collection system
5. Automatic counting and label inserting equipment
6. Paper transporting equipment
7. Automatic paper trimming and collecting machine
8. Electrical controlling system
9. Driving motor
10. Accessory
11. Double lime pneumatic shaftless paper rack
12. Automatic directing and paper tension controller
13. Automatic vacuum

结构特点

- HSC卷筒切纸机采用台湾及英国的先进技术
- AC伺服马达传动，切纸速度快且稳定；
- 德国精密轴承及切断刀，切断精度高；
- 轻触式电脑界面控制，操作简便，
- 构造合理的反曲架，保证纸张的平坦，是目前造纸业及印刷业中普遍采用的纸品加工机械，将为您的公司成倍提高效率，增加收益！

标准配备内容

1. 高精度单刀切纸机
2. 纸张棱角调正系统
3. 静电消除设备
4. 对剖及纸边收集系统
5. 自动计数标签插入设备
6. 纸张运输设备
7. 自动齐纸集纸设备
8. 电器操控系统
9. 驱动马达系统
10. 随机附属品
11. 双臂油压无轴式纸架
12. 自动导达及张力系统(含轨道台车4条)
13. 自动吸尘器设备

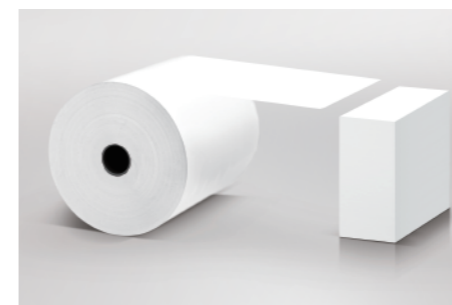

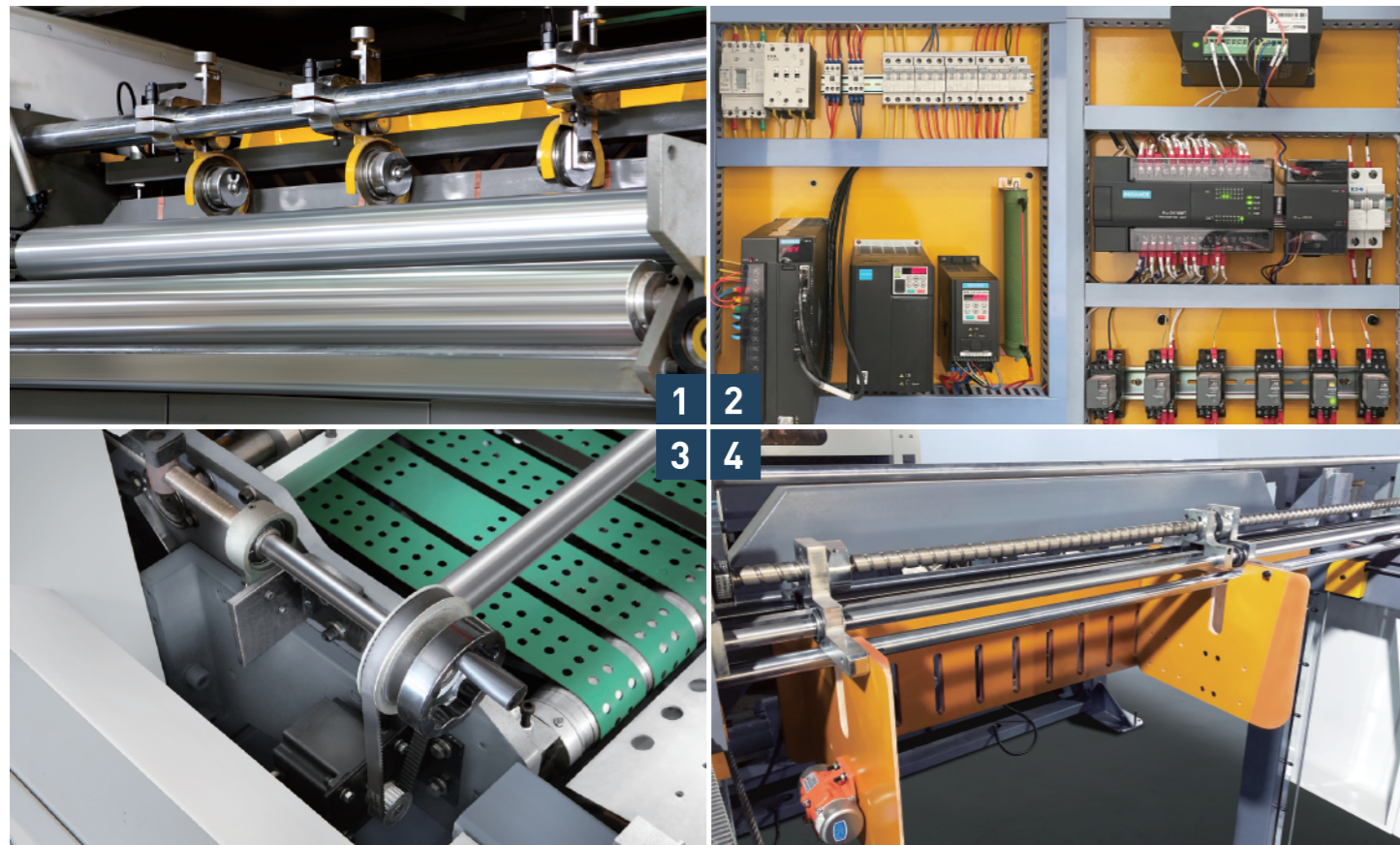

1 SLITTING KNIFE 分条刀 **2 ELECTRONIC CONTROL SYSTEM** 电控系统

Three sets of slitting knife is used to trim and middle slitting.
三组分条刀可供修边及对剖

OPTIONAL(the Yaskawa servo or Siemens PLC) 可选配(安川伺服及西门子PLC)

The man-machine interface and TPC7062KS AND HZU processor, mainly used for the input of production data, monitoring of equipment operating status and system fault indication.. The rotary horizontal cutter is driven by Kymmene TISMGIK drive with fast operation and accurate positioning based on production, and actual speed from pulling roller feedback by encoder.

昆仑通态触摸屏和汇川 HZU 处理器进行通讯,主要用于生产数据的输入、设备运行状态的监控以及系统故障的报警指示。旋转横刀采用汇川公司的 TISMGI 系列驱动器,根据人机界面输入的生产参数和从牵引辊编码器反馈出的实际车速进行快速运算和准确定位。

3 AUTOMATICALLY ADJUST THE ANGLE (PAPER ALIGNING SYSTEM) 自动调对角 **4 AUTOMATIC PILE ALLGNMENT DEVICE AT DELIVERY SECTION** 收纸部采用自动齐纸集纸设备

The precision of the stepper motor is controlled according to the length of cutting sheet, precise screw adjustment the inclination of the knife group, to effectively ensure the straight angle of sheet edge, reduce waste rate and time of manual adjustment.

精准的步进电机按裁切纸长度来控制精密丝杆调整刀组的倾斜度,从而有效地保证了裁切纸边的直角度,降低了人工调整角度的失误率及调整时的浪费。

Lift automatically moves down when the pile is stacked to a considerable height. The stacker table has finishing function of three sides; one side is vibrated by motor, another two sides by air, hand wheel to adjust the position of paper to improve the simplicity and safety of operation.

升降机升降堆叠集纸台,纸张堆叠至相当高度时,即自动下降。堆纸工作台具有三面震动整理功能,一面由电机驱动整纸,两侧由优质气动震动器整纸,并由手轮调整整纸的幅度,提高了操作的简便性和安全性。

MAIN TECHNICAL PARAMETER

主要技术参数

Model	型号	HSC 1400/1700
Reference weight of cutting-paper	纸张范围	50-550g
Model of cutting paper	切纸形式	The up knife cut reciprocally and the down knife is fixed 上刀回切,下刀固定
Cutting accuracy	切断精度	+/-0.3mm
Gross weight	机台总重	11,000kgs/13,000kgs
Total power	总功率	28kw
Power consumption	设计电源	AC380V/220v×50HZ
Maximum cutting speed	最高切断速度	300cuts/min
Maximum cutting meter speed	最高切断米速	300m/min
Cutting length range	切断长度范围	400-1450mm/400-1650mm
Paper-piling height	最大推纸板高度	1400mm
Maximum scroll diameter	最大卷筒纸直径	1800mm(71")Max
Maximum paper-cutting width	最大卷筒纸张幅	1400mm/1700mm
The format of slitting	剖纸幅数	2幅 2sheet
The request for air compressor	气压源需求	Max.5.5kg/cm2×5m3/min] (23kw)

*Our company reserves the right to change technical characteristics without further notice.

*公司有权保留对机器技术参数的修改,恕不另行通知。

HSC 1400/1700 STRUCTURAL ANALYSIS OF FIG 构造解析图

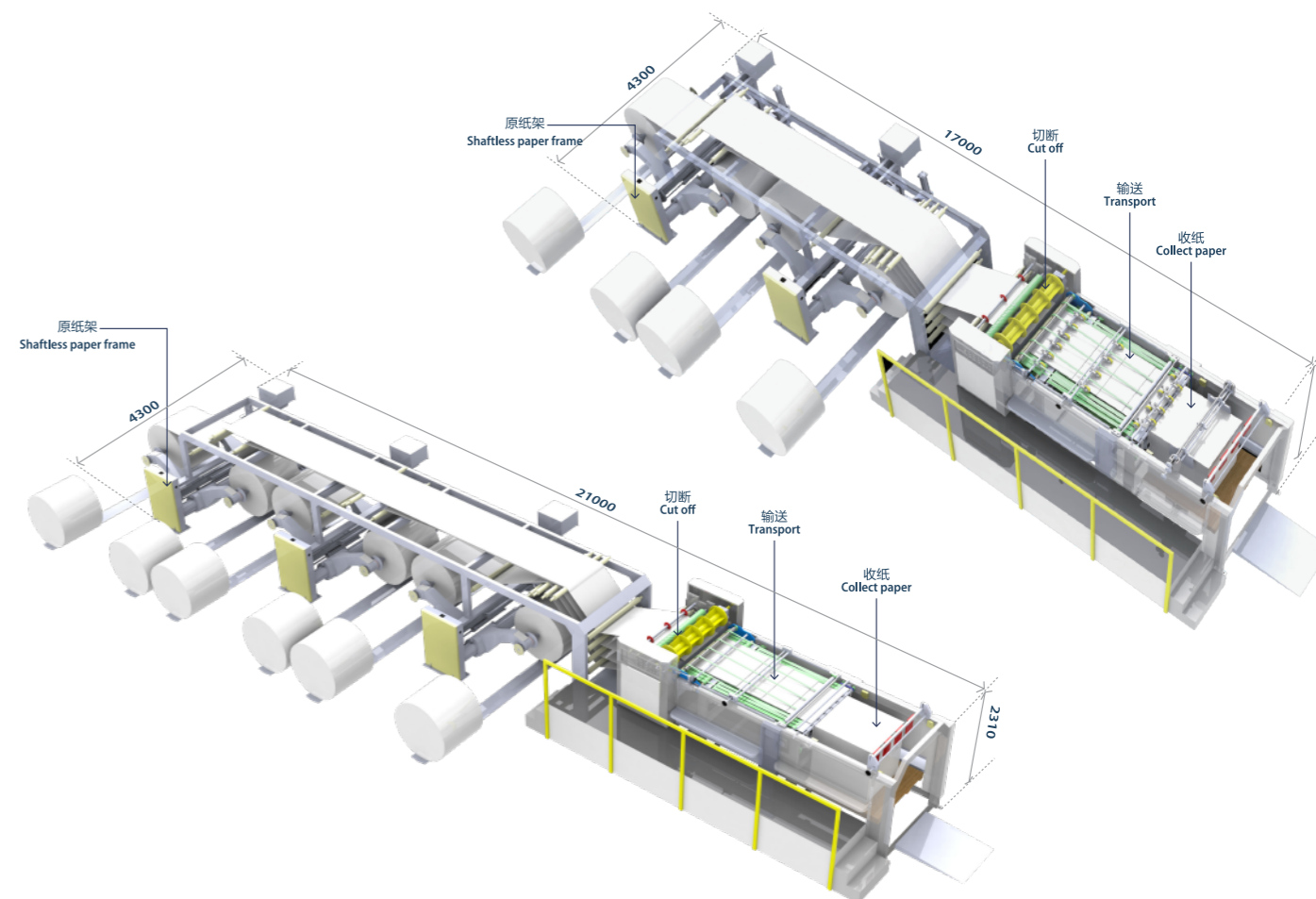

HSC

1400B 1700B 1900B

Servo Driven High Precision Sheet Cutter

伺服传动电脑
高精卷筒纸分切机

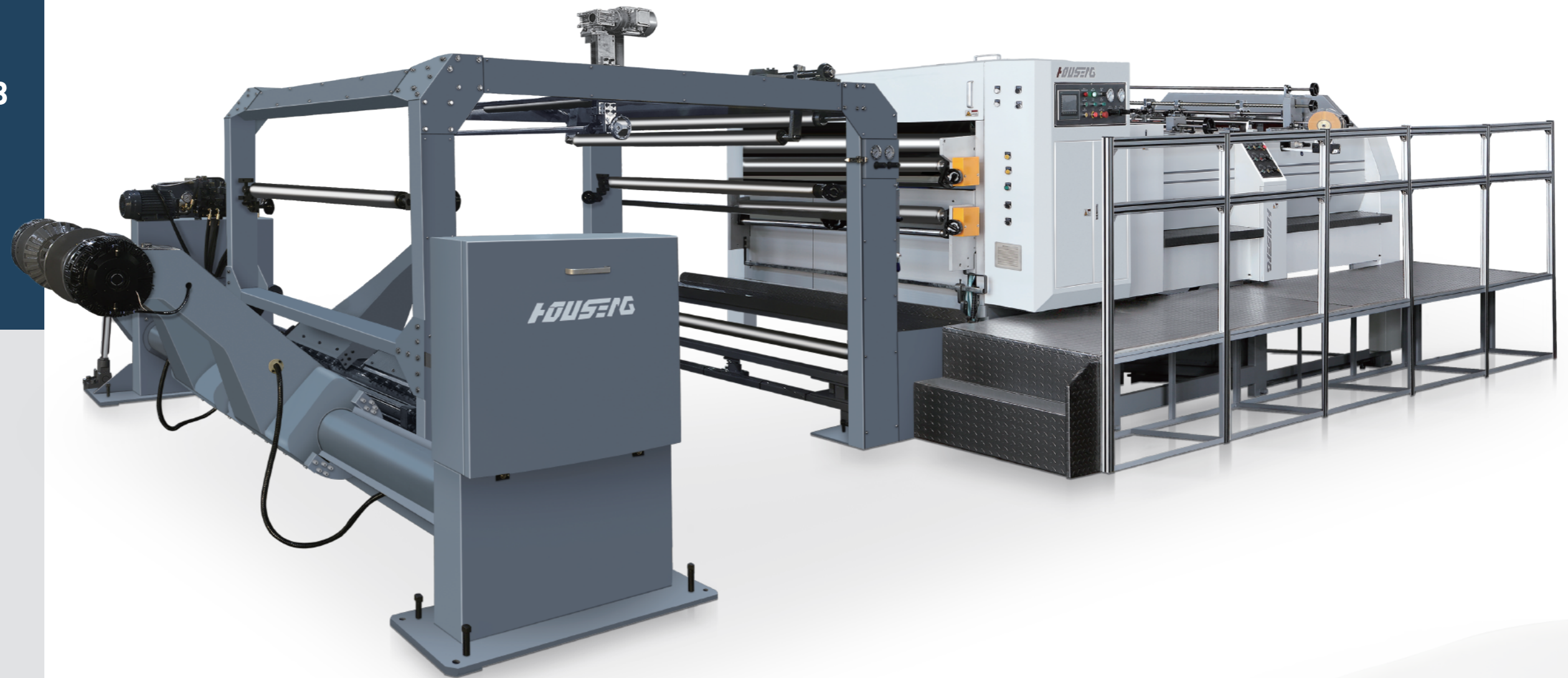
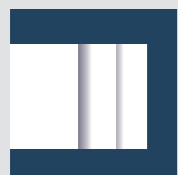
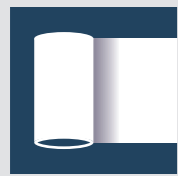

STRUCTURE CHARACTERISTIC

- HSC web cutting machine uses the advanced technology of Taiwan and Britain,
- The machine is driven by AC servo motor.
- The speed of paper cutting is fast and stable.
- Germany precise bearing and cutting knife assure the high cutting precision.
- Touch screen computer interface control, simple operation, reasonable structure,
- Anti-noise stands, to ensure smooth paper.

This machine is widely used in paper making, paper products processing and printing industry, and will improve efficiency and increase benefit for your company.

THE CONTENT OF STANDARD CONFIGURATION

1. High-precision single knife cutting machine
2. Prismatic adjustment system for paper
3. Middle slitting and waste collection system
4. Automatic counting and label inserting equipment
5. Paper transporting equipment
6. Automatic paper trimming and collecting machine
7. Electrical controlling system
8. Driving motor
9. Accessory
10. Double lime pneumatic shaftless paper rack

结构特点

- HSC卷筒切纸机采用台湾及英国的先进技术
- AC伺服马达传动，切纸速度快且稳定；
- 德国精密轴承及切断刀，切断精度高；
- 轻触式电脑界面控制，操作简便，
- 构造合理的反曲架，保证纸张的平坦，是目前造纸业及印刷业中普遍采用的纸品加工机械，将为您的公司成倍提高效率，增加收益！

标准配备内容

1. 高精度单刀切纸机
2. 纸张棱角调整系统
3. 对剖及纸边收集系统
4. 自动计数标签插入设备
5. 纸张运输设备
6. 自动齐纸集纸设备
7. 电器操控系统
8. 驱动马达系统
9. 随机附属品
10. 双臂油压无轴式纸架





1 CUTTING UNIT 切断部分 **2 ELECTRONIC CONTROL SYSTEM** 电控系统

The upper knife uses British cutter method to reduce the load and noise and extend cutter life. The upper knife roller is processed by steel welding and dynamic balance adjustment; effectively reduce vibration and noise of the high-speed operation. The lower knife: knife holder is made by cast iron integrally molded casting and precise processing with good stability. The reverse knife is made of special alloy steel with high precision processing; long life blade is easily adjustable.

上刀采用英国切刀方法，以有效降低切纸时之荷重及噪音，延长切刀寿命。上刀辊体以精钢焊接后作精密加工，并经动态平衡调整，有效降低高速运转时之震动及噪音。
下刀：刀座采用铸铁一体成形铸造，再经精密加工，稳定性佳。
回切刀：以特殊合金钢精密刀加工制成，寿命特长，刀刃容易调校。

3 AUTOMATIC PILE ALLGNMENT DEVICE AT DELIVERY SECTION 收纸部采用自动齐纸集纸设备

Lift automatically moves down when the pile is stacked to a considerable height. The stacker table has finishing function of three sides; one side is vibrated by motor, another two sides by air, hand wheel to adjust the position of paper to improve the simplicity and safety of operation.
升降机升降堆叠集纸台，纸张堆叠至相当高度时，即自动下降。堆纸工作台具有三面震动整理功能，一面由电机驱动整纸，两侧由优质气动震动器整纸，并由手轮调整整纸的幅度，提高了操作的简便性和安全性。

OPTIONAL(the Yaskawa servo or Siemens PLC) 可选配（安川伺服及西门子PLC）

The man-machine interface and TPC7062KS AND HZU processor, mainly used for the input of production data, monitoring of equipment operating status and system fault indication.. The rotary horizontal cutter is driven by Kymmene TISMGIK drive with fast operation and accurate positioning based on production, and actual speed from pulling roller feedback by encoder.
昆仑通态触摸屏和汇川 HZU 处理器进行通讯，主要用于生产数据的输入、设备运行状态的监控以及系统故障的报警指示。旋转横刀采用汇川公司的 TISMGI 系列驱动器，根据人机界面输入的生产参数和从牵引编码器反馈出的实际车速进行快速 运算和准确定位。

4 CURLING DEVICE 曲卷装置

Curling device is In front of slitting device to eliminate curl or folding of web, in order to control stability of web tension. The web first passes through curling components (for the edge of the roll) into pulling roller.
曲卷装置就是在纸卷进入分切装置之前消除纸卷的卷曲度或褶皱的装置，有利于纸卷张力的稳定性。纸卷首先经过（去卷边缘）的部件进入去卷装置，滚筒均为导辊。

MAIN TECHNICAL PARAMETER

主要技术参数

Model	型号	HSC-1400B/1700B
Reference weight of cutting-paper	纸张范围	50-550g
Model of cutting paper	切纸形式	The up knife cut reciprocally and the down knife is fixed 上刀回切，下刀固定
Cutting accuracy	切断精度	+/-0,3mm
Gross weight	机台总重	10,000kgs/13,000kgs
Total power	总功率	28kw
Power consumption	设计电源	AC380V/220v×50HZ
Maximum cutting speed	最高切断速度	300cuts/min
Maximum cutting meter speed	最高切断米速	300m/min
Cutting length range	切断长度范围	400-1450mm/400-1650mm
Paper-piling height	最大推纸板高度	1400mm
Maximum scroll diameter	最大卷筒纸直径	1800mm(71")Max
Maximum paper-cutting width	最大卷筒纸张幅	1400mm/1700mm
The format of slitting	剖纸幅数	2幅 2sheet
The request for air compressor	气压源需求	Max.5.5kg/cm2×5m3/min

*Our company reserves the right to change technical characteristics without further notice.
*公司有权保留对机器技术参数的修改，恕不另行通知。

HSC 1400B/1700B STRUCTURAL ANALYSIS OF FIG 构造解析图

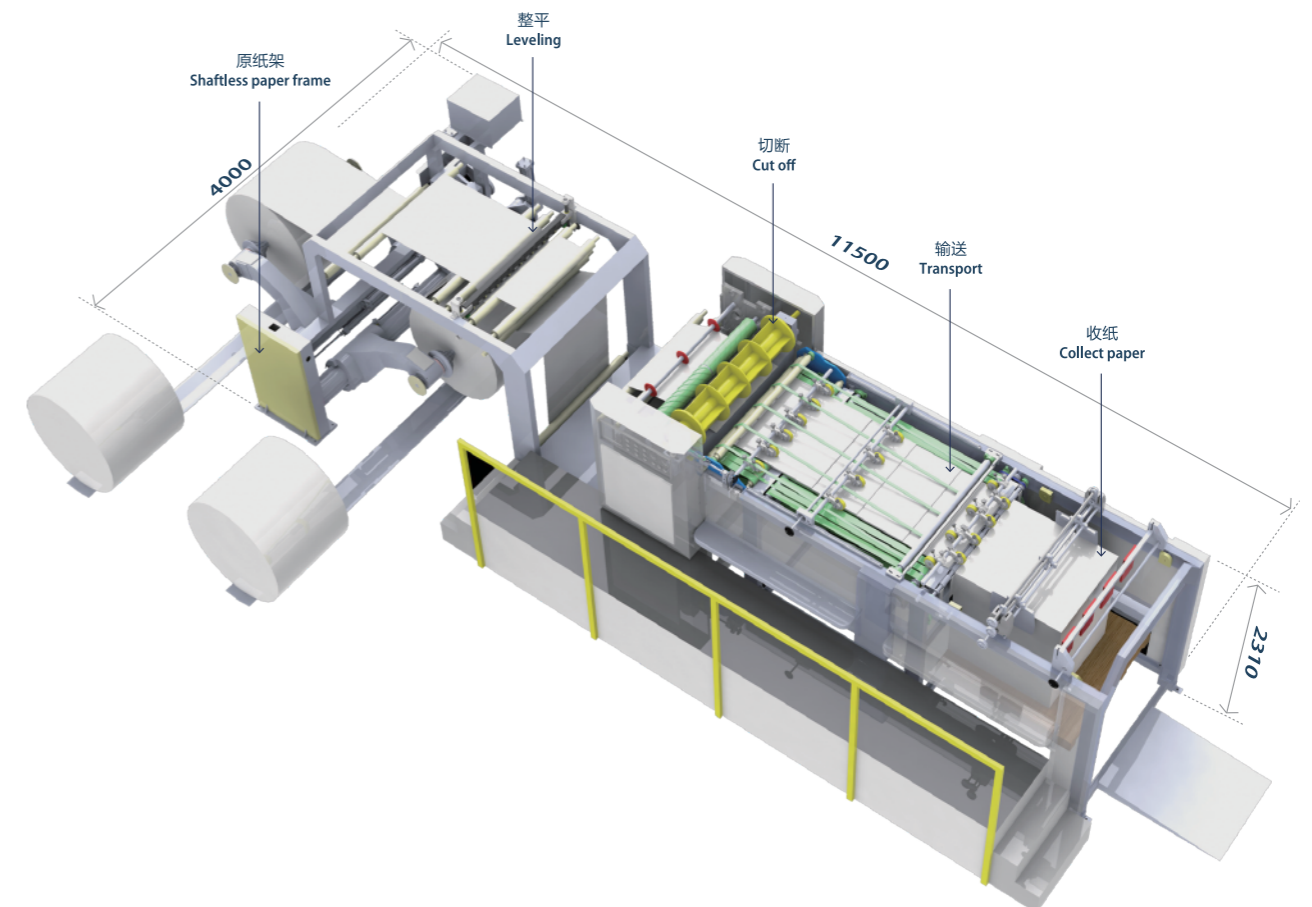

HSC

1400D 1700D 1900D

Servo Driven High Precision
Single Spiral Sheet Cutter

伺服传动电脑高精度
单螺旋卷筒纸分切机



SINGLE SPIRAL
单螺旋

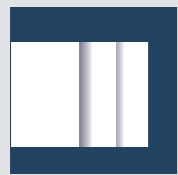
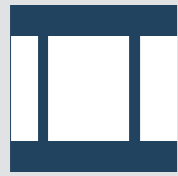
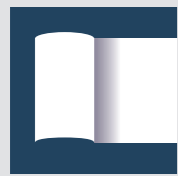

STRUCTURE CHARACTERISTIC

- HSC web cutting machine uses the advanced technology of Taiwan and Britain,
- The machine is driven by AC servo motor.
- The speed of paper cutting is fast and stable.
- Germany precise bearing and cutting knife assure the high cutting precision.
- Touch screen computer interface control, simple operation, reasonable structure,
- Anti-noise stands, to ensure smooth paper.

This machine is widely used in paper making, paper products processing and printing industry, and will improve efficiency and increase benefit for your company.

Single spiral upper knife enables better cutting result with low noise and less burrs.

THE CONTENT OF STANDARD CONFIGURATION

1. High-precision single knife cutting machine
2. Prismatic adjustment system for paper
3. Middle slitting and waste collection system
4. Automatic counting and label inserting equipment
5. Paper transporting equipment
6. Automatic paper trimming and collecting machine
7. Electrical controlling system
8. Driving motor
9. Accessory
10. Double lime pneumatic shaftless paper rack

结构特点

- HSC卷筒切纸机采用台湾及英国的先进技术
- AC伺服马达传动，切纸速度快且稳定；
- 德国精密轴承及切断刀，切断精度高；
- 轻触式电脑界面控制，操作简便，
- 构造合理的反曲架，保证纸张的平坦，是目前造纸业及印刷业中普遍采用的纸品加工机械，将为您的公司成倍提高效率，增加收益！

刀头采用单螺旋设计，有效降低噪音，增加切纸边缘的平滑度，减少毛边。

标准配备内容

1. 高精度单刀切纸机
2. 纸张棱角调正系统
3. 对剖及纸边收集系统
4. 自动计数标签插入设备
5. 纸张运输设备
6. 自动齐纸集纸设备
7. 电器操控系统
8. 驱动马达系统
9. 随机附属品
10. 双臂油压无轴式纸架



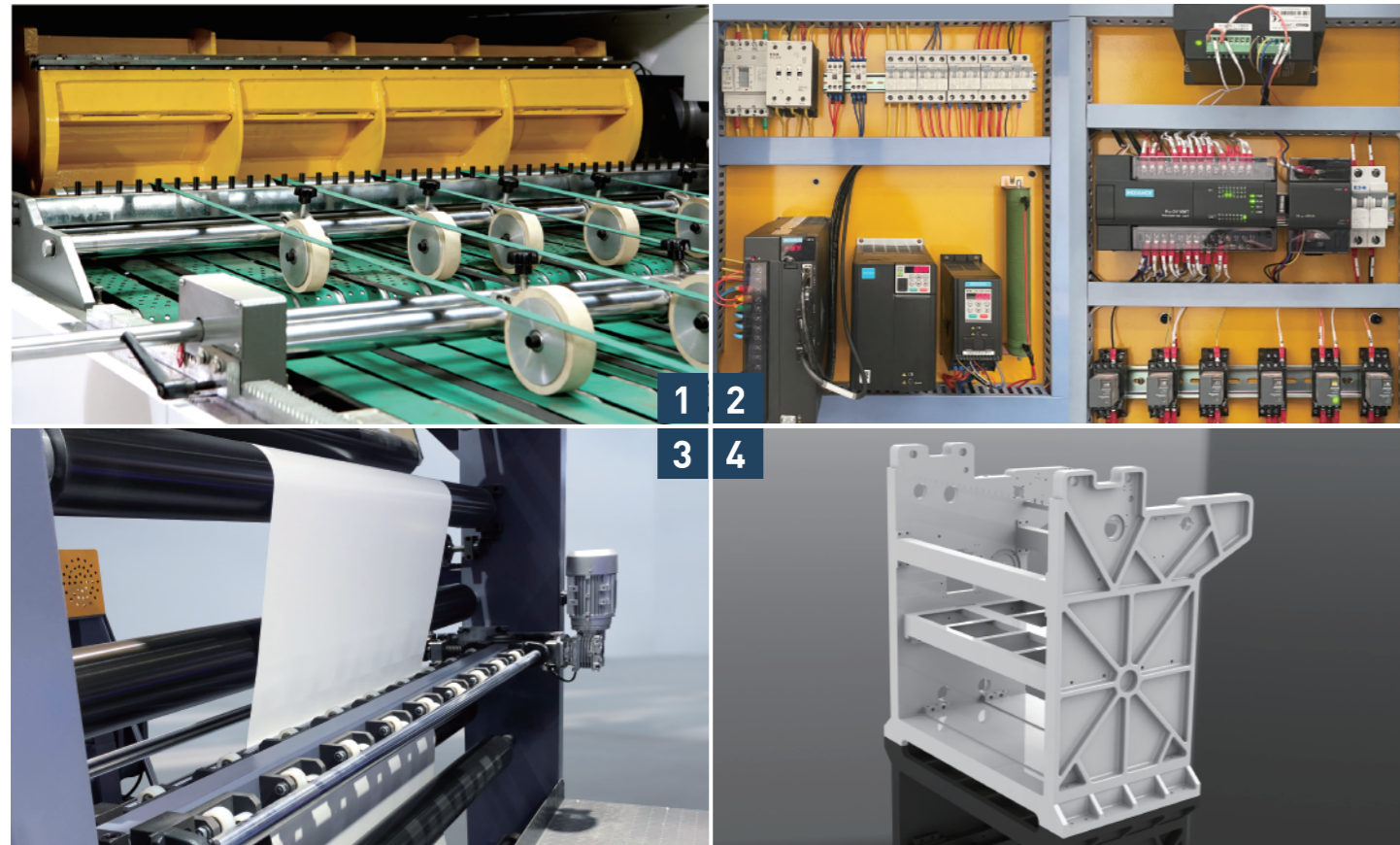

1 CUTTING UNIT 切断部分 **2 ELECTRONIC CONTROL SYSTEM** 电控系统

OPTIONAL(the Yaskawa servo or Siemens PLC) 可选配(安川伺服及西门子PLC)

The upper knife uses British cutter method to reduce the load and noise and extend cutter life. The upper knife roller is processed by steel welding and dynamic balance adjustment; effectively reduce vibration and noise of the high-speed operation. The lower knife: knife holder is made by cast iron integrally molded casting and precise processing with good stability. The reverse knife is made of special alloy steel with high precision processing; long life blade is easily adjustable.

上刀采用英国切刀方法,以有效降低切纸时之荷重及噪音,延长切刀寿命。上刀辊体以精钢焊接后作精密加工,并经动态平衡调整,有效降低高速运转时之震动及噪音。

下刀:刀座采用铸铁一体成形铸造,再经精密加工,稳定性佳。回切刀:以特殊合金钢精密刀加工制成,寿命特长,刀刃容易调校。

The man-machine interface and TPC7062KS AND HZU processor, mainly used for the input of production data, monitoring of equipment operating status and system fault indication.. The rotary horizontal cutter is driven by Kymmene TISMGIK drive with fast operation and accurate positioning based on production, and actual speed from pulling roller feedback by encoder.

昆仑通态触摸屏和汇川 HZU 处理器进行通讯,主要用于生产数据的输入、设备运行状态的监控以及系统故障的报警指示。旋转横刀采用汇川公司的 TISMGI 系列驱动器,根据人机界面输入的生产参数和从牵引辊编码器反馈出的实际车速进行快速运算和准确定位。

3 CURLING DEVICE 曲卷装置 **4 THE MAIN MACHINE STRUCTURE** 机身结构

Curling device is in front of slitting device to eliminate curl or folding of web, in order to control stability of web tension. The web first passes through curling components (for the edge of the roll) into pulling roller.

曲卷装置就是在纸卷进入分切装置之前消除纸卷的卷曲度或褶皱的装置,有利于纸卷张力的稳定性。纸卷首先经过(去卷边缘)的部件进入去卷装置,滚筒均为导辊。

The main machine wall is optimized through finite element analysis, to eliminate mechanical resonance of all transportation parts, use the high quality nodular cast iron by integration design, and through precise processing, make the machine running more stable, improve working life of bearing parts.

主机壁经过有限元分析、机械震动分析及机架的优化设计,采用优质球墨铸铁进行一体化设计,并经过精密加工,完善解决各传动部件间的共振现象,使机构运行更加稳定,提高了轴承等易损件的使用寿命。

MAIN TECHNICAL PARAMETER

主要技术参数

Model	型号	HSC 1400D/1700D
Reference weight of cutting-paper	纸张范围	50-550g
Model of cutting paper	切纸形式	The up knife cut reciprocally and the down knife is fixed 上刀回切,下刀固定
Cutting accuracy	切断精度	+/-0.3mm
Gross weight	机台总重	14.000kgs/16.000kgs
Total power	总功率	28kw
Power consumption	设计电源	AC380V/220v×50HZ
Maximum cutting speed	最高切断速度	400cuts/min
Maximum cutting meter speed	最高切断米速	400m/min
Cutting length range	切断长度范围	400-1450mm/400-1650mm
Paper-piling height	最大推纸板高度	1400mm
Max. roll diameter	最大卷筒纸直径	1800mm(71")Max
Maximum paper-cutting width	最大卷筒纸张幅	1400mm/1700mm
The format of slitting	剖纸幅数	2幅 2sheet
The request for air compressor	气压源需求	Max.5.5kg/cm2×5m3/min

*Our company reserves the right to change technical characteristics without further notice.

*公司有权保留对机器技术参数的修改,恕不另行通知。

HSC 1400D/1700D STRUCTURAL ANALYSIS OF FIG 构造解析图

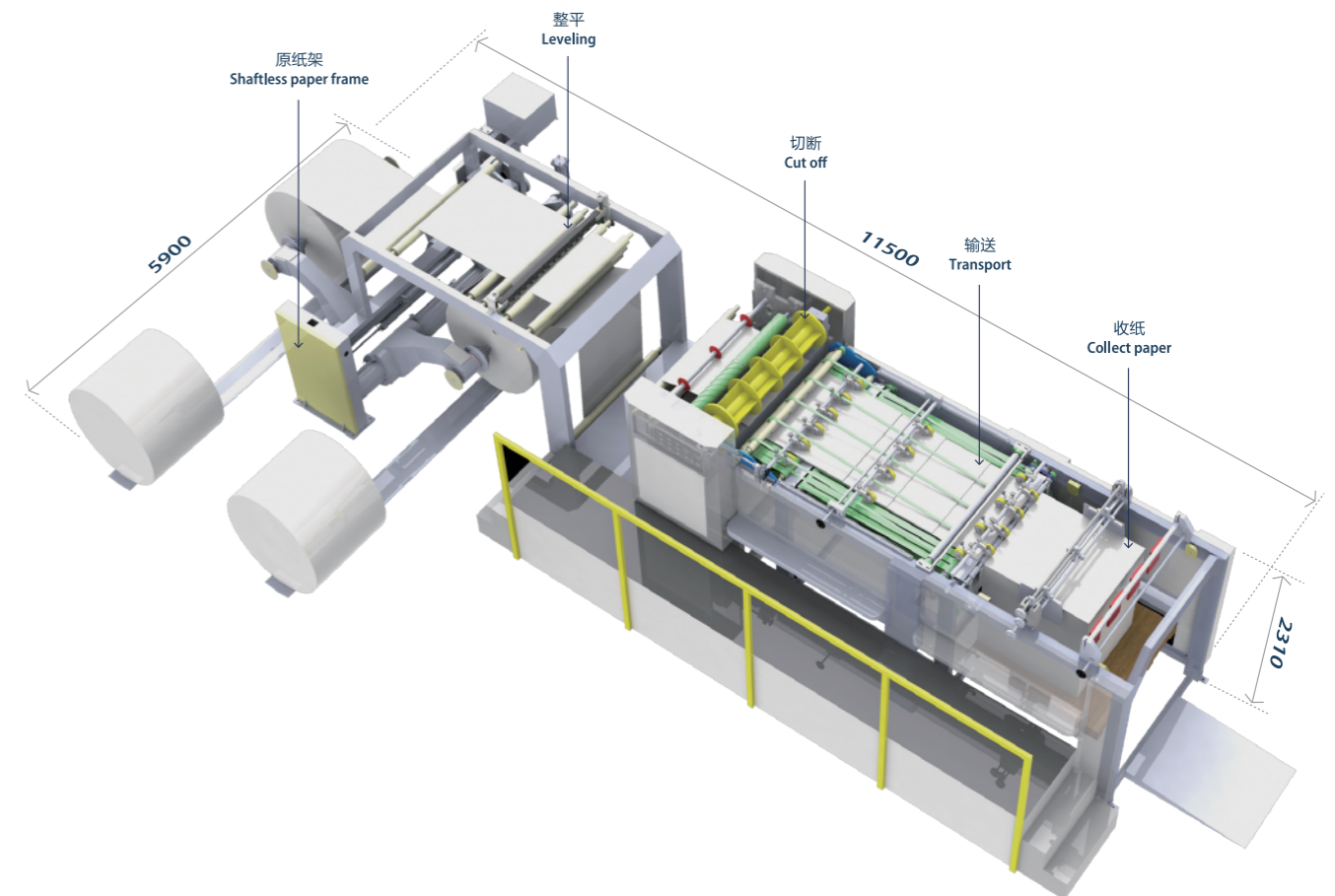

HSCJ

1400A 1700A 1900A

Servo-driven High
Speed Sheet Cutter

滚刀式伺服驱动
电脑切纸机

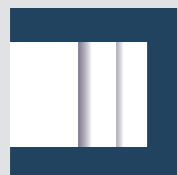
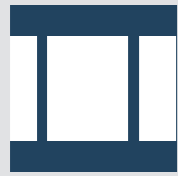
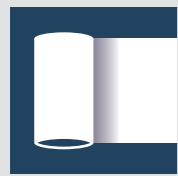

STRUCTURE CHARACTERISTIC

- HSC web cutting machine uses the advanced technology of Taiwan and Britain,
- The machine is driven by AC servo motor, motion controller is made in UK.
- The speed of paper cutting is fast and stable.
- Germany precise bearing and cutting knife assure the high cutting precision.
- Touch screen computer interface control, simple operation, reasonable structure,
- Anti-noise stands, to ensure smooth paper.

This machine is widely used in paper making, paper products processing and printing industry, and will improve efficiency and increase benefit for your company.

Single spiral upper knife enables better cutting result with low noise and less burrs.

THE CONTENT OF STANDARD CONFIGURATION

The upper knife uses British cutter method to reduce the load and noise and extend cutter life.

The upper knife roller is processed by steel welding and dynamic balance adjustment; effectively reduce vibration and noise of the high-speed operation.

The lower knife: knife holder is made by cast iron integrally molded casting and precise processing with good stability. The reverse knife is made of special alloy steel with high precision processing; long life blade is easily adjustable.

Safety cover: Power is off automatically when safety cover is opened, safe and secured.
Transmission: key bearing from German FAG, other bearings from Japan NSK, transmission belt assure high precision and stable paper transmission.

结构特点

- HSCJ系列滚刀式伺服驱动电脑切纸机是本公司结合国内外先进技术并完善创新开发的一款经济型切纸机,
 - 本机电脑控制AC伺服电机传动并增加英国产运动控制器, 具有切纸速度快且稳定;
 - 德国精密轴承及切断刀, 切断精度高; 使用寿命长。
 - 轻触式电脑操控介面, 美观方便。
 - 设计合理的反曲架, 能保正纸张的平坦。
- 它领先于目前国内纸品及印刷业同类的加工机器, 并将为贵公司成倍提高生产效率, 增加产量和效益!

标准配备内容

上刀: 采用英国切刀方法, 以有效降低切纸时之荷重及噪音, 延长切刀之寿命。上刀辊体以精钢焊接后作精密加工, 并经动态平衡调整, 有效降低高速运转时之震动及噪音。

下刀: 刀座采用铸铁一体成形铸造, 再经精密加工, 稳定性佳。主动辊: 辊面有扩张纹路设计, 并以气囊控制辊体之加压纸。回切刀: 以特殊合金钢精密刀加工制成, 寿命特长, 刀刃容易调较。

安全罩: 安全罩掀开即自动断电, 安全有保障。

传动: 关键轴承采用德国FAG, 其他轴承采用日本NSK传动带, 精度高传动稳定。

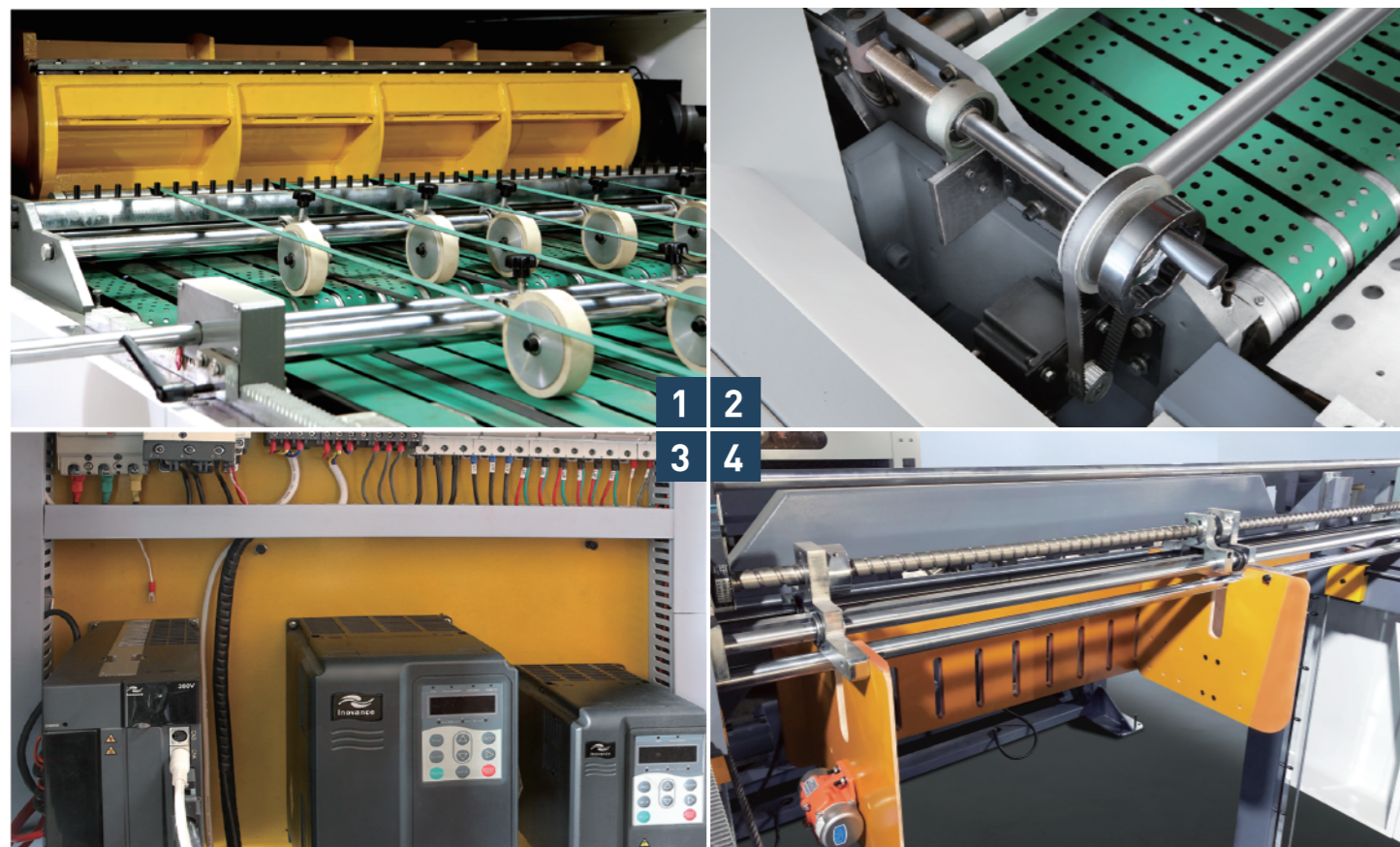

1 CUTTING UNIT 切断部分 **2 AUTOMATICALLY ADJUST THE ANGLE PAPER ALIGNING SYSTEM** 自动调对角

The upper knife uses British cutter method to reduce the load and noise and extend cutter life. The upper knife roller is processed by steel welding and dynamic balance adjustment; effectively reduce vibration and noise of the high-speed operation. The lower knife: knife holder is made by cast iron integrally molded casting and precise processing with good stability. The reverse knife is made of special alloy steel with high precision processing; long life blade is easily adjustable.

上刀采用英国切刀方法,以有效降低切纸时之荷重及噪音,延长切刀寿命。上刀辊体以精钢焊接后作精密加工,并经动态平衡调整,有效降低高速运转时之震动及噪音。

下刀:刀座采用铸铁一体成形铸造,再经精密加工,稳定性佳。
回切刀:以特殊合金钢精密刀加工制成,寿命特长,刀刃容易调校。

The precision of the stepper motor is controlled according to the length of cutting sheet, precise screw adjustment the inclination of the knife group, to effectively ensure the straight angle of sheet edge, reduce waste rate and time of manual adjustment.

精准的步进电机按裁切纸长度来控制精密丝杆调整刀组的倾斜度,从而有效地保证了裁切纸边的直角度,降低了人工调整角度的失误率及调整时的浪费。

3 ELECTRONIC CONTROL SYSTEM 电控系统 **4 AUTOMATIC PILE ALIGNMENT DEVICE AT DELIVERY SECTION** 收纸部采用自动齐纸集纸设备

OPTIONAL(the Yaskawa servo or Siemens PLC) 可选配(安川伺服及西门子PLC)

The man-machine interface and TPC7062KS and HZU processor, mainly used for the input of production data, monitoring of equipment operating status and system fault indication. The rotary horizontal cutter is driven by Kymmene TISMGIK drive with fast operation and accurate positioning based on production, and actual speed from pulling roller feedback by encoder.

昆仑通态触摸屏和汇川 HZU 处理器进行通讯,主要用于生产数据的输入、设备运行状态的监控以及系统故障的报警指示。旋转横刀采用汇川公司的 TISMGI 系列驱动器,根据人机界面输入的生产参数和从牵引辊编码器反馈出的实际车速进行快速运算和准确定位。

Lift automatically moves down when the pile is stacked to a considerable height. The stacker table has finishing function of three sides; one side is vibrated by motor, another two sides by air, hand wheel to adjust the position of paper to improve the simplicity and safety of operation.

升降机升降堆叠集纸台,纸张堆叠至相当高度时,即自动下降。堆纸工作台具有三面震动整理功能,一面由电机驱动整纸,两侧由优质气动震动器整纸,并由手轮调整整纸的幅度,提高了操作的简便性和安全性。

MAIN TECHNICAL PARAMETER

主要技术参数

Model	型号	HSCJ-1400A/1700A
Reference weight of cutting-paper	纸张范围	50-550g
Model of cutting paper	切纸形式	The up knife cut reciprocally and the down knife is fixed 上刀回切,下刀固定
Max.Diameter of roll	最大卷筒纸直径	1800mm (71")Max
Total Power	总功率	25kw
Max.Pieces of paper	最大纸幅	1400mm(55")Max/1700mm(65")Max
Cutting length	切断长度	400-1450mm/400-1650mm
Cutting accuracy	切断精度	+/-0.3mm
Maximum cutting speed	最高切断速度	300cuts/min
Maximum cutting meter speed	最高切断米速	300m/min

*Our company reserves the right to change technical characteristics without further notice.

*公司有权保留对机器技术参数的修改,恕不另行通知。

HSCJ 1400A/1700A STRUCTURAL ANALYSIS OF FIG 构造解析图

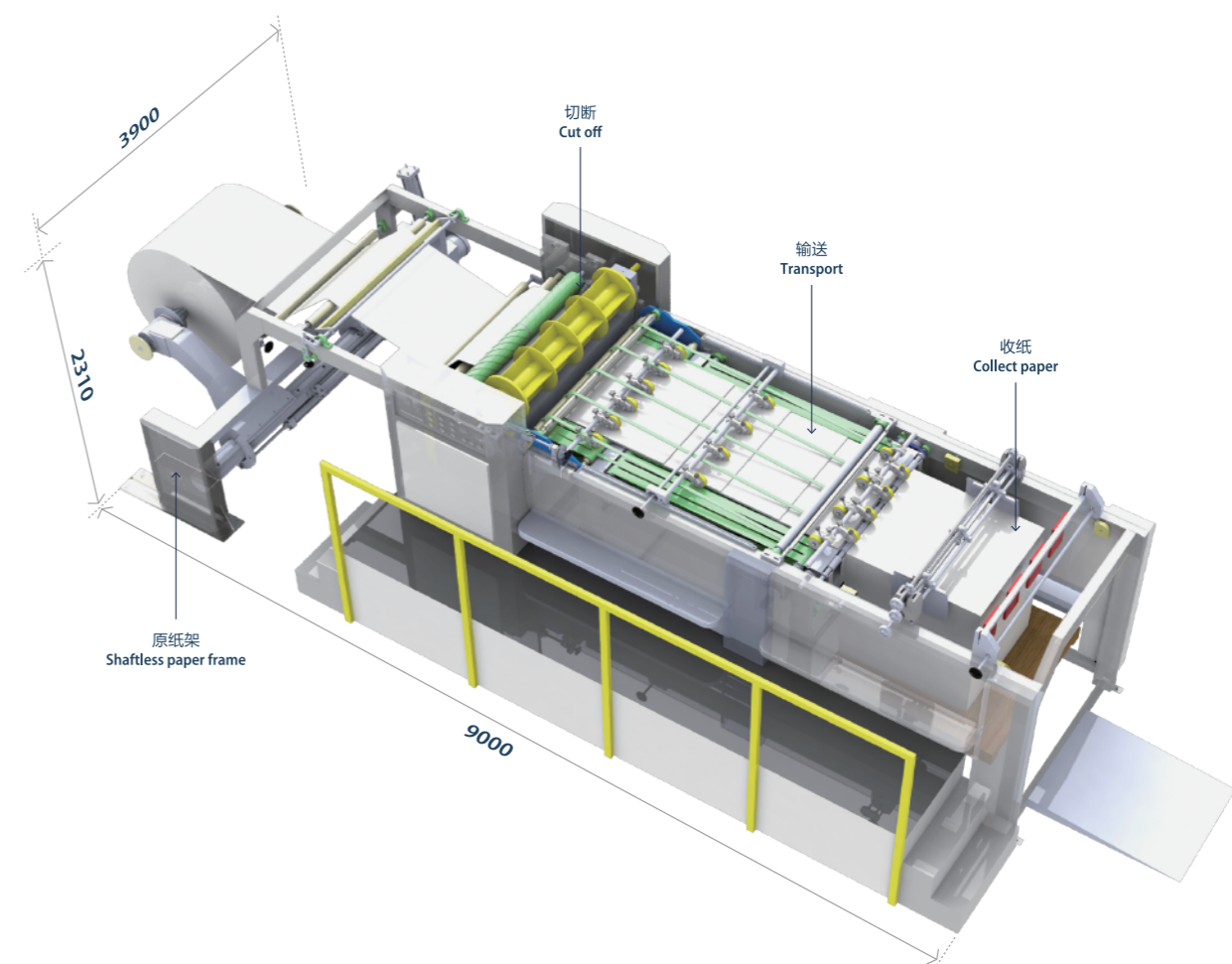

HSCJ

1400B 1700B 1900B

Servo-driven High
Speed Sheet Cutter

滚刀式伺服驱动
电脑切纸机

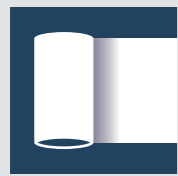

STRUCTURE CHARACTERISTIC

- HSC web cutting machine uses the advanced technology of Taiwan and Britain,
- The machine is driven by AC servo motor, motion controller is made in UK.
- The speed of paper cutting is fast and stable.
- Germany precise bearing and cutting knife assure the high cutting precision.
- Touch screen computer interface control, simple operation, reasonable structure,
- Anti-noise stands, to ensure smooth paper.

This machine is widely used in paper making, paper products processing and printing industry, and will improve efficiency and increase benefit for your company.

Single spiral upper knife enables better cutting result with low noise and less burrs.

THE CONTENT OF STANDARD CONFIGURATION

The upper knife uses British cutter method to reduce the load and noise and extend cutter life.

The upper knife roller is processed by steel welding and dynamic balance adjustment; effectively reduce vibration and noise of the high-speed operation.

The lower knife: knife holder is made by cast iron integrally molded casting and precise processing with good stability. The reverse knife is made of special alloy steel with high precision processing; long life blade is easily adjustable.

Safety cover: Power is off automatically when safety cover is opened, safe and secured.
Transmission: key bearing from German FAG, other bearings from Japan NSK, transmission belt assure high precision and stable paper transmission.

结构特点

- HSCJ系列滚刀式伺服驱动电脑切纸机是本公司结合国内外先进技术并完善创新开发的一款经济型切纸机,
- 本机电脑控制AC伺服电机传动并增加英国产运动控制器, 具有切纸速度快且稳定;
- 德国精密轴承及切断刀, 切断精度高; 使用寿命长。
- 轻触式电脑操控介面, 美观方便。
- 设计合理的反曲架, 能保正纸张的平坦。
它领先于目前国内纸品及印刷业同类的加工机器, 并将为贵公司成倍提高生产效率, 增加产量和效益!

标准配备内容

上刀: 采用英国切刀方法, 以有效降低切纸时之荷重及噪音, 延长切刀之寿命。上刀辊体以精钢焊接后作精密加工, 并经过动态平衡调整, 有效降低高速运转时之震动及噪音。

下刀: 刀座采用铸铁一体成形铸造, 再经精密加工, 稳定性佳。主动辊: 辊面有扩张纹路设计, 并以气囊控制辊体之加压纸。回切刀: 以特殊合金钢精密刀加工制成, 寿命特长, 刀刃容易调较。

安全罩: 安全罩掀开即自动断电, 安全有保障。
传动: 关键轴承采用德国FAG, 其他轴承采用日本NSK传动带, 精度高传动稳定。

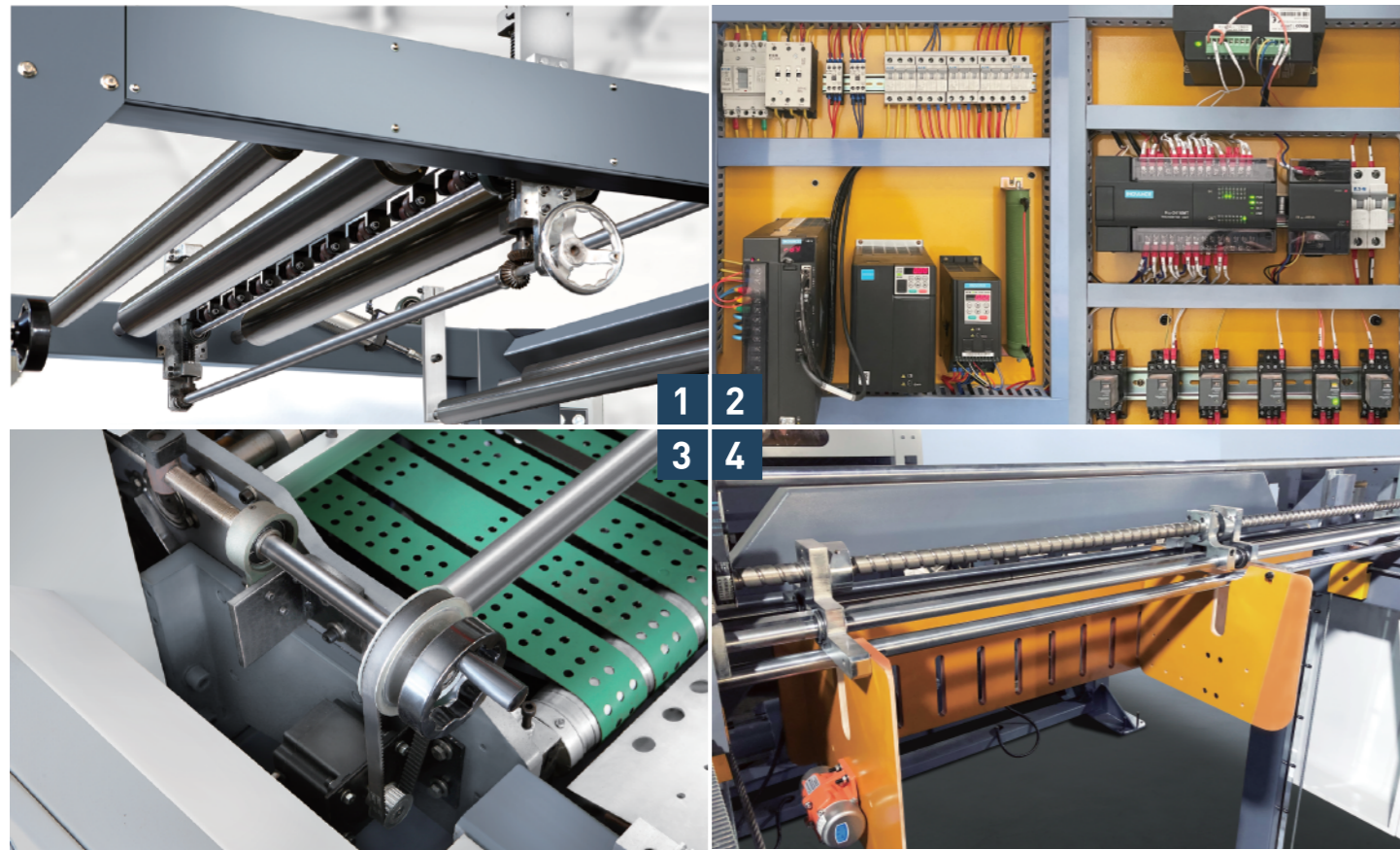

1 NEW LEVELING DEVICE 新型整平装置

Effectively remove the curl of the roll to make paper more flat, Benefit for tension stability of rolls.

有效的去除纸卷的卷曲度,使纸张更为平坦,更有利于纸卷张力的稳定性。

2 ELECTRONIC CONTROL SYSTEM 电控系统

OPTIONAL(the Yaskawa servo or Siemens PLC) 可选配(安川伺服及西门子PLC)

The man-machine interface and TPC7062KS AND HZU processor, mainly used for the input of production data, monitoring of equipment operating status and system fault indication.. The rotary horizontal cutter is driven by Kymmene TISMGIK drive with fast operation and accurate positioning based on production, and actual speed from pulling roller feedback by encoder.

昆仑通态触摸屏和汇川 HZU 处理器进行通讯,主要用于生产数据的输入、设备运行状态的监控以及系统故障的报警指示。旋转横刀采用汇川公司的 TISMGI 系列驱动器,根据人机界面输入的生产参数和从牵引编码器反馈出的实际车速进行快速运算和准确定位。

3 AUTOMATICALLY ADJUST THE ANGLE PAPER ALIGNING SYSTEM 自动调对角

The precision of the stepper motor is controlled according to the length of cutting sheet, precise screw adjustment the inclination of the knife group, to effectively ensure the straight angle of sheet edge, reduce waste rate and time of manual adjustment.

精准的步进电机按裁切纸长度来控制精密丝杆调整刀组的倾斜度,从而有效地保证了裁切纸边的直角度,降低了人工调整角度的失误率及调整时的浪费。

4 AUTOMATIC PILE ALLGNMENT DEVICE AT DELIVERY SECTION 收纸部采用自动齐纸集纸设备

Lift automatically moves down when the pile is stacked to a considerable height. The stacker table has finishing function of three sides; one side is vibrated by motor, another two sides by air, hand wheel to adjust the position of paper to improve the simplicity and safety of operation.

升降机升降堆叠集纸台,纸张堆叠至相当高度时,即自动下降。堆纸工作台具有三面震动整理功能,一面由电机驱动整纸,两侧由优质气动震动器整纸,并由手轮调整整纸的幅度,提高了操作的简便性和安全性。

MAIN TECHNICAL PARAMETER

主要技术参数

Model	型号	HSCJ-1400B/1700B
Reference weight of cutting-paper	纸张范围	50-550g
Model of cutting paper	切纸形式	The up knife cut reciprocally and the down knife is fixed 上刀回切,下刀固定
Max.Diameter of roll	最大卷筒纸直径	1800mm (71")Max
Total Power	总功率	25kw
Max.Pieces of paper	最大纸幅	1400mm(55")Max/1700mm(65")Max
Cutting length	切断长度	400-1450mm/400-1650mm
Cutting accuracy	切断精度	+/-0.3mm
Maximum cutting speed	最高切断速度	300cuts/min
Maximum cutting meter speed	最高切断米速	300m/min

*Our company reserves the right to change technical characteristics without further notice.

*公司有权保留对机器技术参数的修改,恕不另行通知。

HSCJ 1400B/1700B

STRUCTURAL ANALYSIS OF FIG

构造解析图

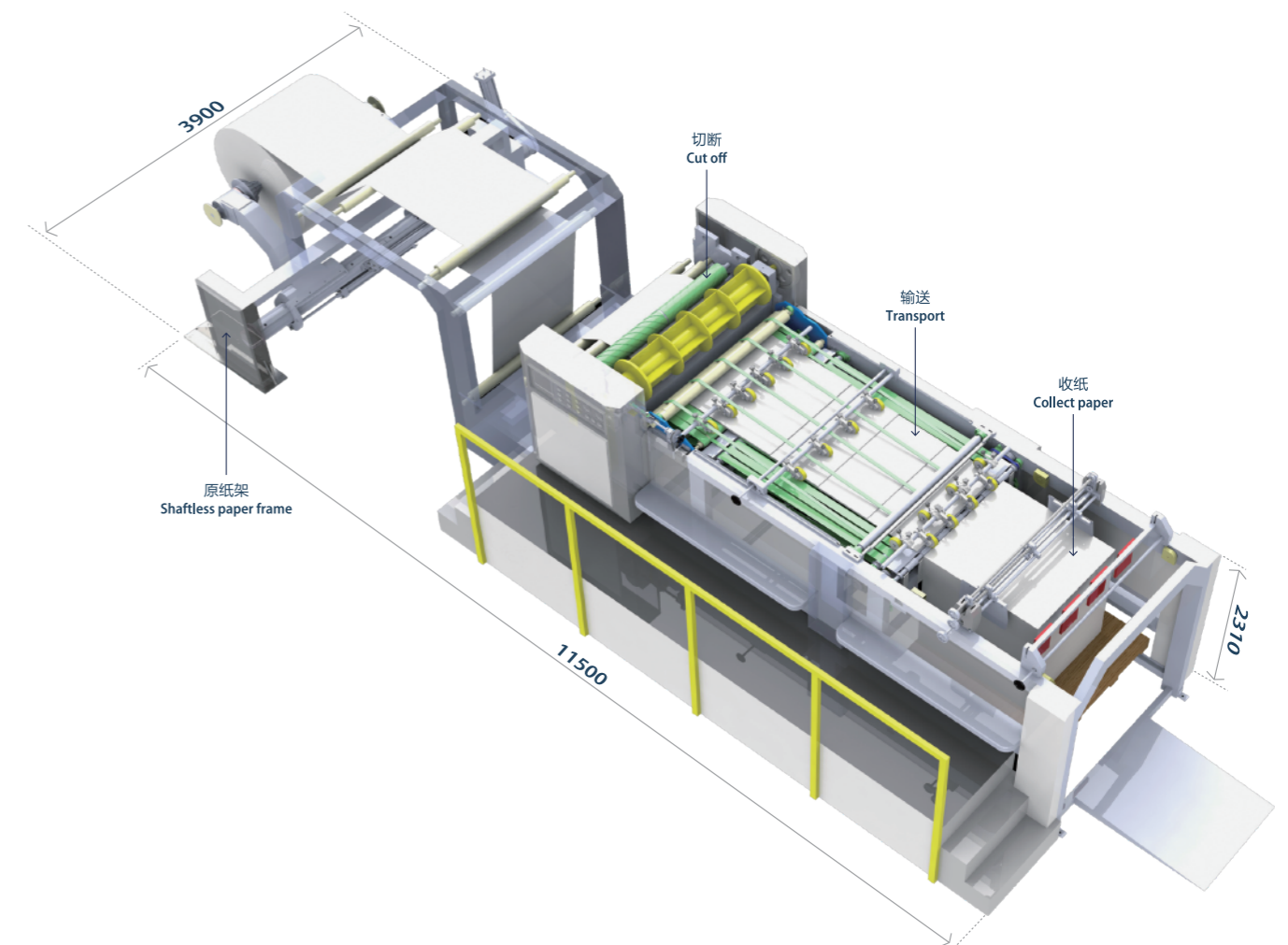

HSCJ

1400D 1700D 1900D

Servo Driven High Precision
Single Spiral Sheet Cutter

伺服传动电脑高精度
单螺旋卷筒纸分切机



SINGLE SPIRAL
单螺旋

STRUCTURE CHARACTERISTIC

- HSC web cutting machine uses the advanced technology of Taiwan and Britain,
- The machine is driven by AC servo motor.
- The speed of paper cutting is fast and stable.
- Germany precise bearing and cutting knife assure the high cutting precision.
- Touch screen computer interface control, simple operation, reasonable structure,
- Anti-noise stands, to ensure smooth paper.

This machine is widely used in paper making, paper products processing and printing industry, and will improve efficiency and increase benefit for your company.

THE CONTENT OF STANDARD CONFIGURATION

1. High-precision single knife cutting machine
2. Prismatic adjustment system for paper
3. Middle slitting and waste collection system
4. Automatic counting and label inserting equipment
5. Paper transporting equipment
6. Automatic paper trimming and collecting machine
7. Electrical controlling system
8. Driving motor
9. Accessory
10. Double lime pneumatic shaftless paper rack

结构特点

- HSC卷筒切纸机采用台湾及英国的先进技术
- AC伺服马达传动，切纸速度快且稳定；
- 德国精密轴承及切断刀，切断精度高；
- 轻触式电脑界面控制，操作简便，
- 构造合理的反曲架，保证纸张的平坦，是目前造纸业及印刷业中普遍采用的纸品加工机械，将为您的公司成倍提高效率，增加收益！

标准配备内容

1. 高精度单刀切纸机
2. 纸张棱角调正系统
3. 对剖及纸边收集系统
4. 自动计数标签插入设备
5. 纸张运输设备
6. 自动齐纸集纸设备
7. 电器操控系统
8. 驱动马达系统
9. 随机附属品
10. 双臂油压无轴式纸架

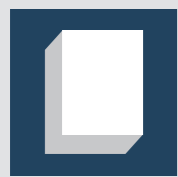
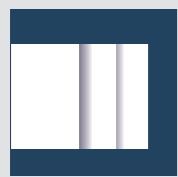
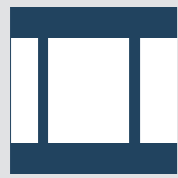

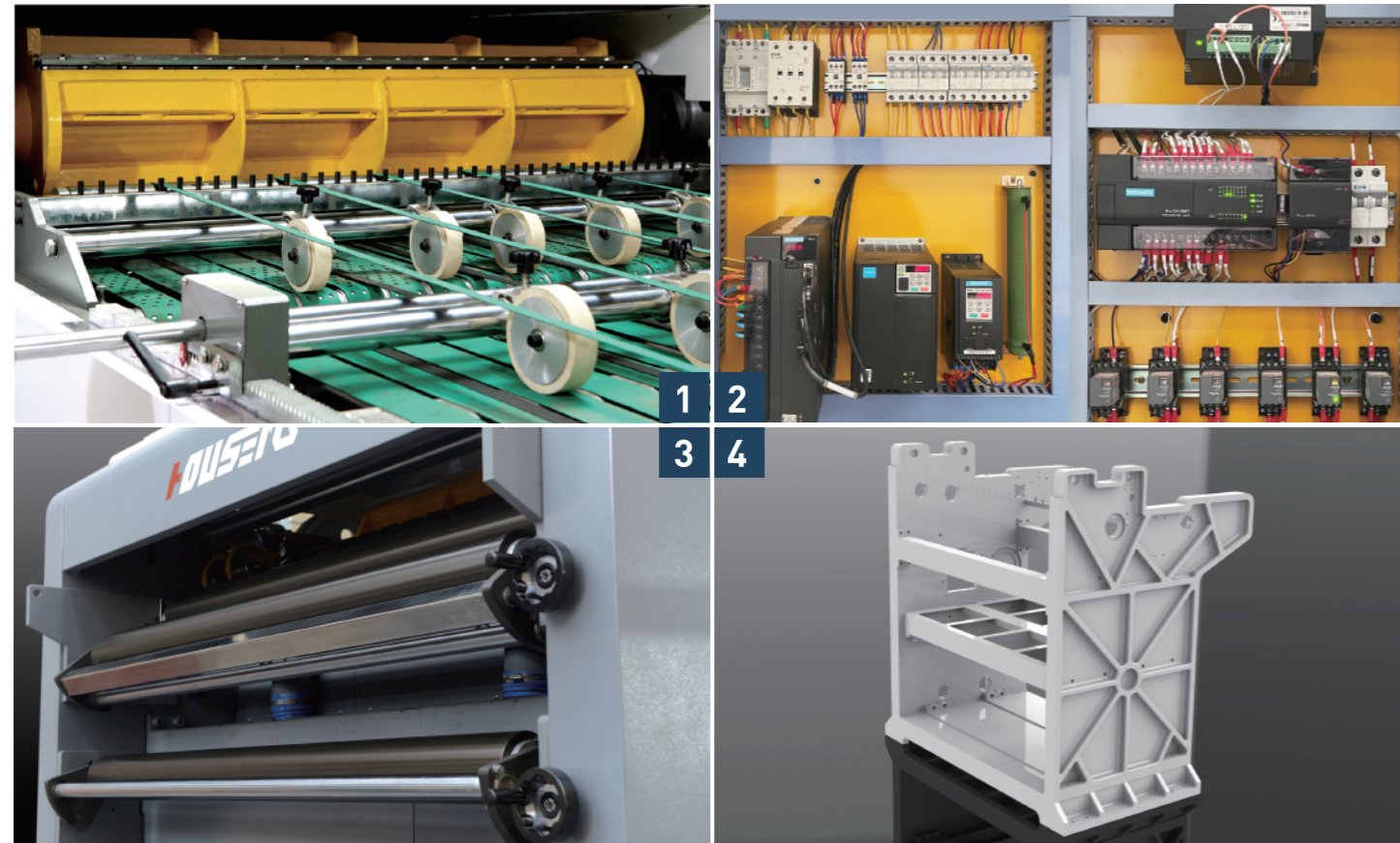

1 CUTTING UNIT 切断部分

The upper knife uses British cutter method to reduce the load and noise and extend cutter life. The upper knife roller is processed by steel welding and dynamic balance adjustment; effectively reduce vibration and noise of the high-speed operation. The lower knife: knife holder is made by cast iron integrally molded casting and precise processing with good stability. The reverse knife is made of special alloy steel with high precision processing; long life blade is easily adjustable.

上刀采用英国切刀方法，以有效降低切纸时之荷重及噪音，延长切刀寿命。上刀辊体以精钢焊接后作精密加工，并经动态平衡调整，有效降低高速运转时之震动及噪音。

下刀：刀座采用铸铁一体成形铸造，再经精密加工，稳定性佳。
回切刀：以特殊合金钢精密刀加工制成，寿命特长，刀刃容易调校。

3 CURLING DEVICE 曲卷装置

Curling device is in front of slitting device to eliminate curl or folding of web, in order to control stability of web tension. The web first passes through curling components (for the edge of the roll) into pulling roller.

曲卷装置就是在纸卷进入分切装置之前消除纸卷的卷曲度或褶皱的装置，有利于纸卷张力的稳定性。纸卷首先经过（去卷边缘）的部件进入去卷装置，滚筒均为导辊。

2 ELECTRONIC CONTROL SYSTEM 电控系统

OPTIONAL(the Yaskawa servo or Siemens PLC) 可选配（安川伺服及西门子PLC）

The man-machine interface and TPC7062KS AND HZU processor, mainly used for the input of production data, monitoring of equipment operating status and system fault indication.. The rotary horizontal cutter is driven by Kymmene TISMG1K drive with fast operation and accurate positioning based on production, and actual speed from pulling roller feedback by encoder.

昆仑通态触摸屏和汇川 HZU 处理器进行通讯，主要用于生产数据的输入、设备运行状态的监控以及系统故障的报警指示。旋转横刀采用汇川公司的 TISMG1 系列驱动器，根据人机界面输入的生产参数和从牵引辊编码器反馈出的实际车速进行快速运算和准确定位。

4 THE MAIN MACHINE STRUCTURE 机身结构

The main machine wall is optimized through finite element analysis, to eliminate mechanical resonance of all transportation parts, use the high quality nodular cast iron by integration design, and through precise processing, make the machine running more stable, improve working life of bearing parts.

主机壁经过有限元分析、机械震动分析及机架的优化设计，采用优质球墨铸铁进行一体化设计，并经过精密加工，完善解决各传动部件间的共振现象，使机构运行更加稳定，提高了轴承等易损件的使用寿命。

MAIN TECHNICAL PARAMETER

主要技术参数

Model	型号	HSCJ 1400D/1700D
Reference weight of cutting-paper	纸张范围	50-550g
Model of cutting paper	切纸形式	The up knife cut reciprocally and the down knife is fixed 上刀回切，下刀固定
Cutting accuracy	切断精度	+/-0.3mm
Gross weight	机台总重	14,000kgs/16,000kgs
Total power	总功率	28kw
Power consumption	设计电源	AC380V/220v×50HZ
Maximum cutting speed	最高切断速度	400cuts/min
Maximum cutting meter speed	最高切断米速	400m/min
Cutting length range	切断长度范围	400-1450mm/400-1650mm
Paper-piling height	最大推纸板高度	1400mm
Maximum scroll diameter	最大卷筒纸直径	1800mm(71")Max
Maximum paper-cutting width	最大卷筒纸张幅	1400mm/1700mm
The format of slitting	剖纸幅数	2幅 2sheet
The request for air compressor	气压源需求	Max.5.5kg/cm2×5m3/min

*Our company reserves the right to change technical characteristics without further notice.

*公司有权保留对机器技术参数的修改，恕不另行通知。

HSCJ 1400D/1700D STRUCTURAL ANALYSIS OF FIG 构造解析图

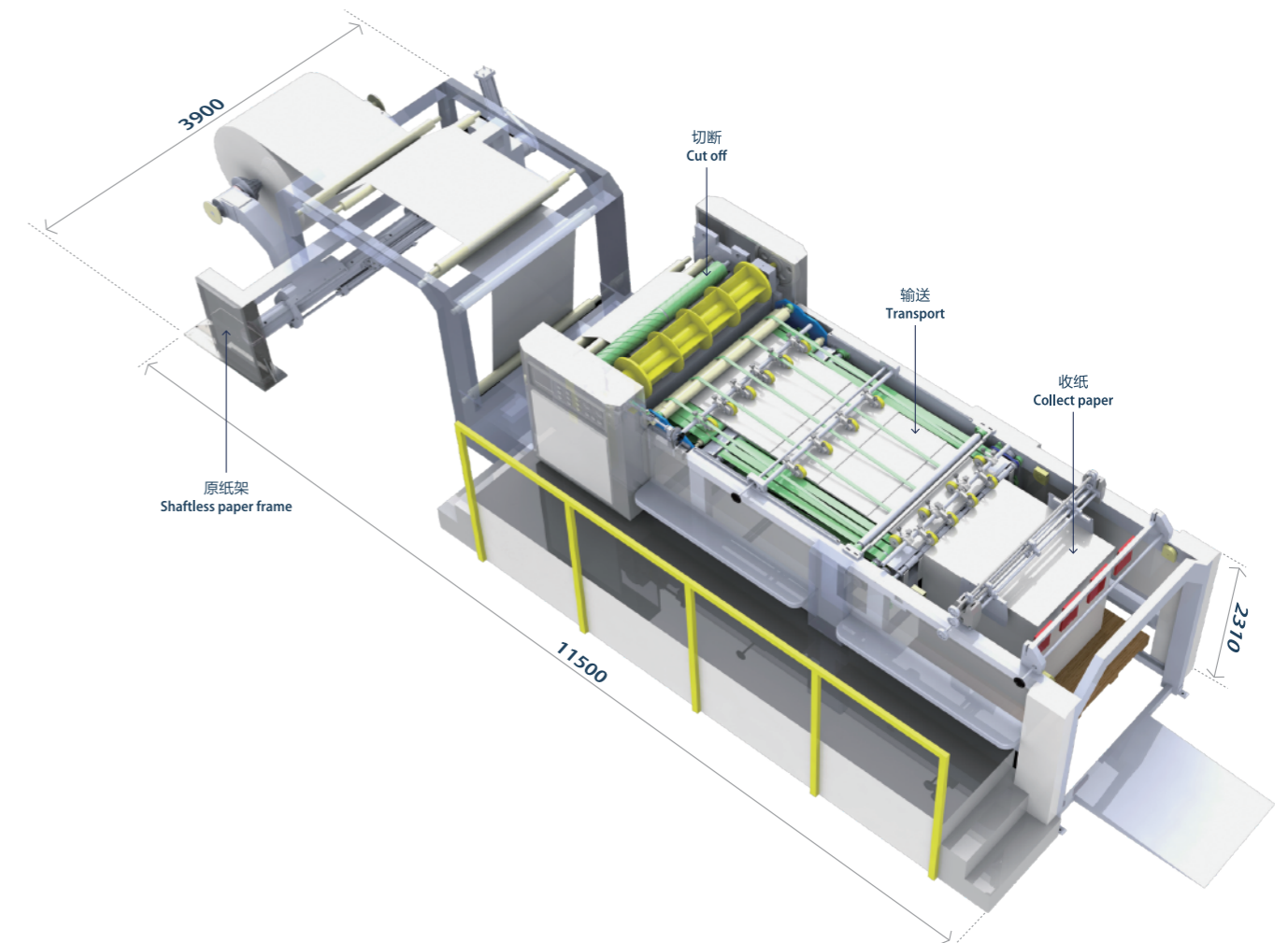



PARTICULAR HUMAN CONCERN AND PROFESSIONAL & DEDICATED SALES SERVICE SYSTEM

独具人性关怀
与专业热忱的销售服务体系

HIGH QUALITY SERVICE 优质的服务

- 简便的操作，让工艺变的如此简单，
- 我们拥有专业的销售人员和技术人员，时刻准备以专业知识、精湛的技艺让您的购买与使用过程中充满自信。
- 现已形成良好的服务体系网络，在华东、华南、华北等地区设立售后服务部，快捷、及时服务为用户，同时终身免收服务工时费。
- 专业高效的维修服务、纯正的零部件供应以及迅捷准确的信息反馈，确保您无论身在何处，都能享受豪盛优质和一致的关爱。
- Easy operation makes the process so simple
- We have professional sales people and technicians, who are always ready to serve you with their expertise and exquisite skills, which makes you buy and use our equipment with confidence.
- We have established well-developed service system and network. After sale service departments are available in East, South, and North China, and they can provide quick and timely service for users, always free of maintenance man-hour cost.
- Professional and efficient maintenance service, supply of original parts, and prompt & accurate feedback make sure that you have access to high quality and consistent care from HAOSHENG wherever you are.



提供全天候电话咨询服务；
7X24-hour Telephone Consulting Service is available.



对于用户提出的服务要求，在最短时间内给予答复并拿出解决方案；
Reply and solution will be provided in the shortest time upon customer's service request.



售后人员随时待命，为客户解决各项疑难问题；
After-sales support is available on a 7X24-hour basis, leaving no worries for customers.



提供免费的安装、调试，售后人员会告知客户如何进行产品保养的常识；
Equipment transportation and installation & commissioning are all free.
After-sale service personnel will tell you how to maintain the equipment.



设备交货一周内，售后人员会进行电话跟踪咨询，直到客户满意为止；
After delivery of equipment, after-sale service personnel will give you a follow up phone call until you are satisfied.



拥有我们的设备，即享受一年保修，终身维护。
Once you have our equipment, you will enjoy one year warranty and life time maintenance.

GLOBAL SALES NETWORK



**A PROFESSIONAL MANUFACTURER
OF SHEET CUTTER MACHINE**

做最优秀的卷筒切纸机

ASIA

China
Japan
Thailand
Vietnam
Myanmar
Malaysia
Indonesia
Philippines
Saudi Arabia
Iran
Pakistan
UAE
India
Kazakhstan

EUROPE

Germany
United Kingdom
France
Russia
Portugal
Czech
Poland
Norway
Bosnia
Estonia

AMERICAS

Canada
United States Of America
Mexico
Argentina
Brazil
Chile

AFRICA

Egypt
South Africa

OCEANIA

Australia
New Zealand

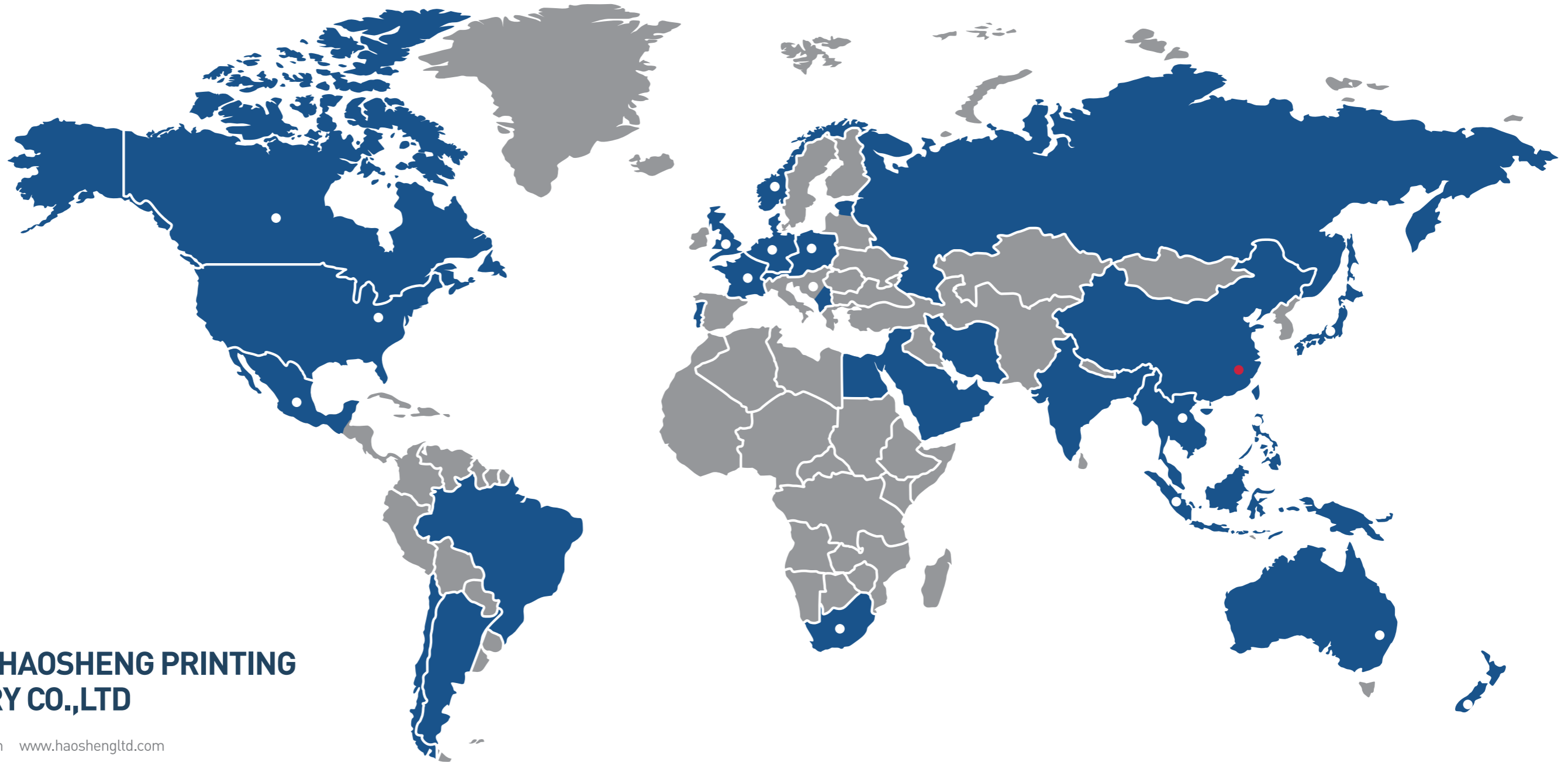

**ZHEJIANG HAOSHENG PRINTING
MACHINERY CO.,LTD**

www.china-ruifeng.com www.haoshengltd.com